

MANDIK®

CONSTANT AIR VOLUME CONTROLLER SQUARE RPMC-K



These technical specifications state a row of manufactured sizes and models of square constant air volume controller (further only controller) RPMC-K. It is valid for production, designing, ordering, delivery, assembly and operation.

I. CONTENT

II. GENERAL INFORMATION	3
1. Description.....	3
2. Design.....	4
3. Dimensions, weights.....	4
4. Placement and Assembly.....	6
III. TECHNICAL DATA	7
5. Basic parameters.....	7
6. Electrical Components, Wiring diagrams.....	9
7. Pressure loss.....	11
8. Noise data.....	11
IV. MATERIAL, FINISHING	36
9. Material.....	36
V. INSPECTION, TESTING	36
10. Inspection, testing.....	36
VI. TRANSPORTATION AND STORAGE	36
11. Logistics terms.....	36
VII. ORDERING INFORMATION	37
12. Ordering key.....	37

II. GENERAL INFORMATION

1. Description

Fig. 1 Controller RPMC-K



1.1. Constant mechanical air volume controllers are meant for input or output air systems. Controllers can be installed in horizontal or vertical position with horizontal blade axis. The aerodynamic forces acting the list due to the flow are compensated by the control device adjusted according required flow.

Mechanical controllers need not be connected to any external power source.

Adjustment of required flow is simply performed by lever with a pointer and scale.

The controller consists of the casing of the controller with a control blade and control device. Control device is placed inside of box with scale for adjustment of required flow. Accuracy of the scale is $\pm 5\%$.

1.2. Controller characteristics

- Nominal size 200x100 ÷ 600x600
- Length L = 350
- Thickness acc. to EN 1751 External casing leakage class ATC 3 (old marking "C")
- Air flow volume 250 ÷ 12 000 m³/h
- Accuracy 10% -15% (on the min./max. positions 20%)

1.3. Working conditions

The faultless functioning of the controllers is ensured under the following conditions::

- a) maximum speed of air flow 10 m/s
- b) maximum pressure in the duct 1000 Pa
- c) the air circulation in the whole controller section must be secured as steady on whole surface

Controllers are designed for macroclimatic areas with mild climate according to EN 60 721-3-3.

Controllers are suitable for systems without abrasive, chemical and adhesive particles.

Temperature in the place of installation is permitted to range from 0°C to + 50°C.

2. Design

2.1. The controller consists of the casing of the controller with a control blade and control device. Sliding bearings of blade axis are plastic. Control device consist of spring and shock absorber. On the top of control device box is lever with a pointer and scale for adjustment of required flow.

Controllers can be alternatively equipped by actuating mechanism. It enable remote adjustment of required flow. In this case actuating mechanism don't control controller damper. Actuating mechanism control setting of lever for adjustment of required flow. If is used actuating mechanism temperature range is from 0°C to + 50°C.

The controller body can be alternatively insulated.

Fig. 2 Square constant air volume controller

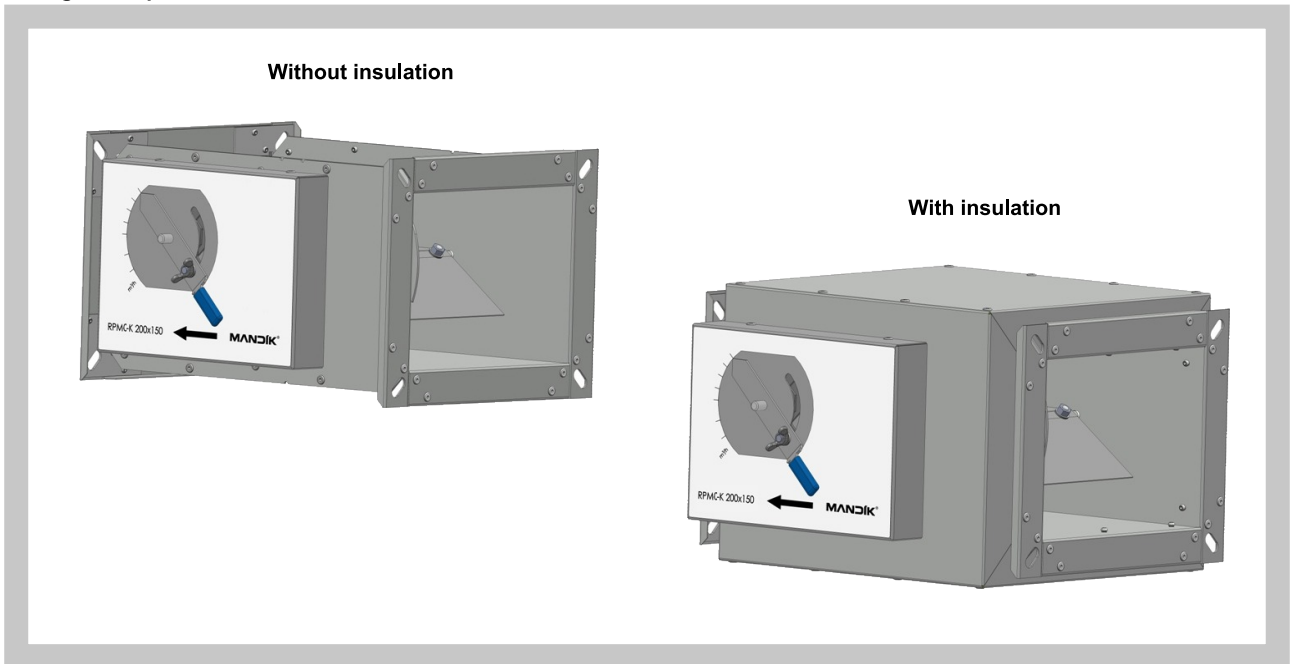

3. Dimensions, weights

3.1. Dimensions, weights

Fig. 3 Square constant air volume controller - mechanical control

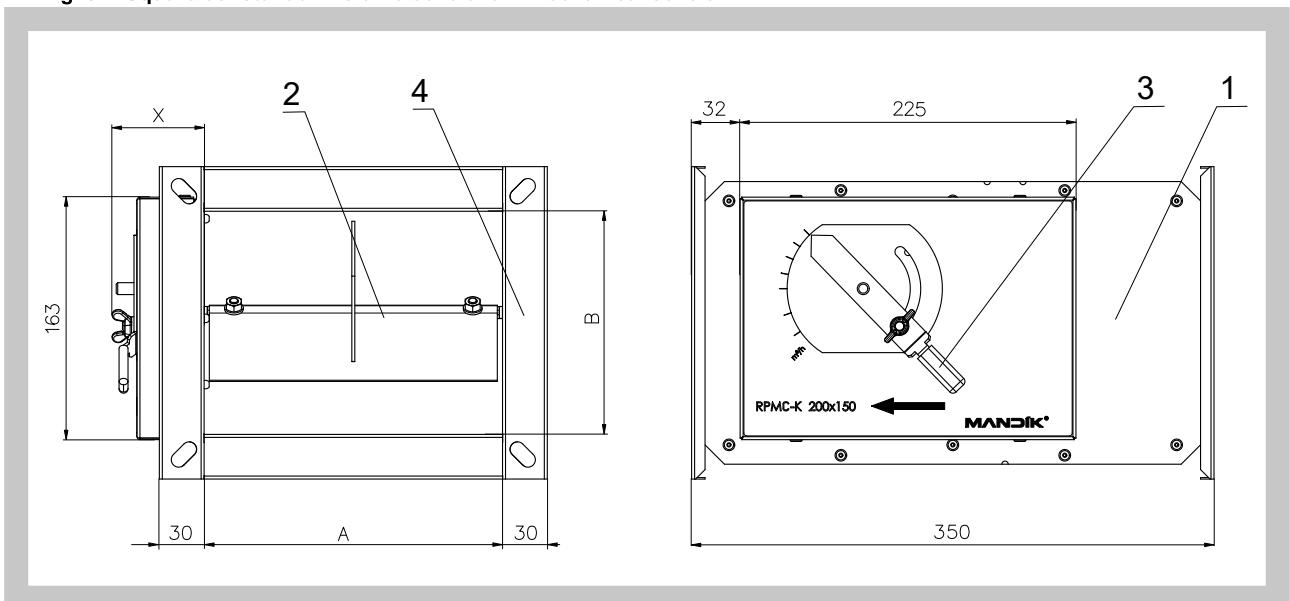

Fig. 4 Square constant air volume controller - with insulation, mechanical control

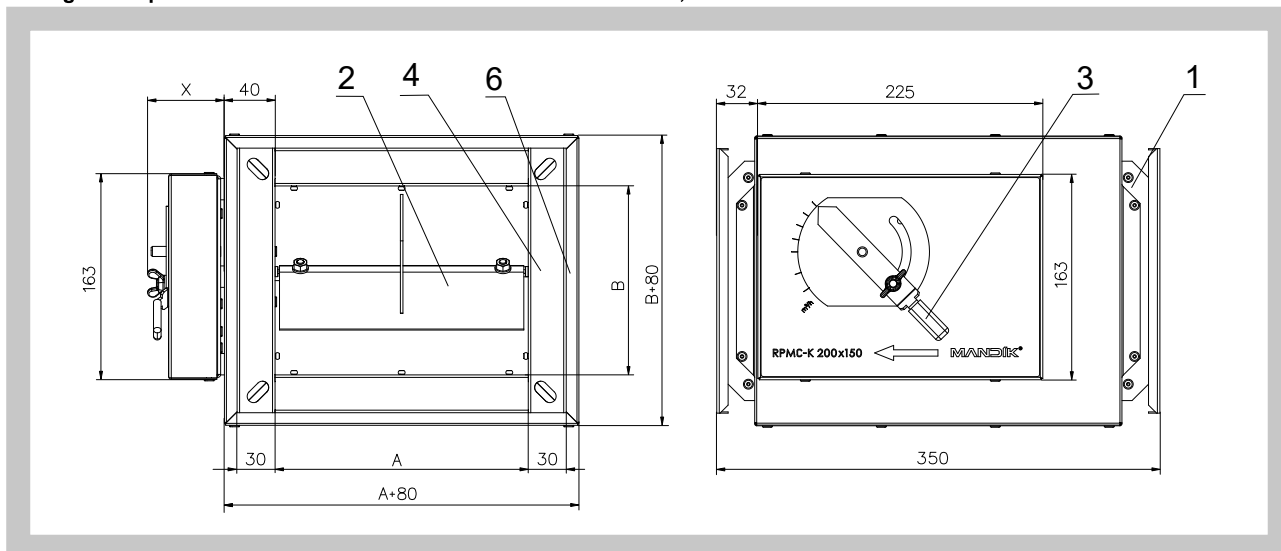

Fig. 5 Square constant air volume controller - actuating mechanism

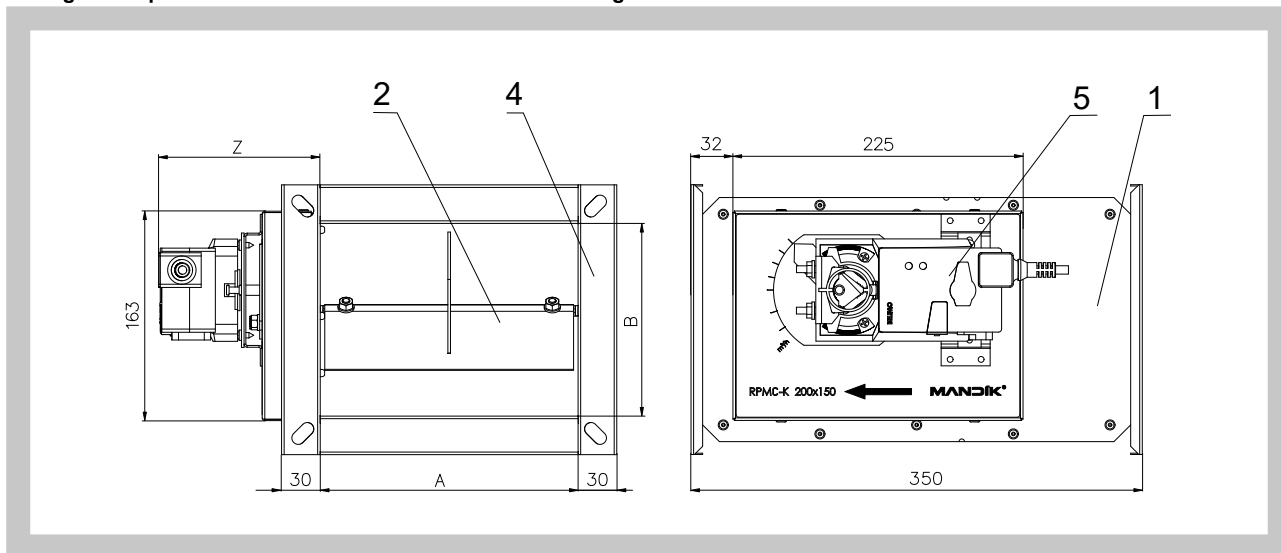
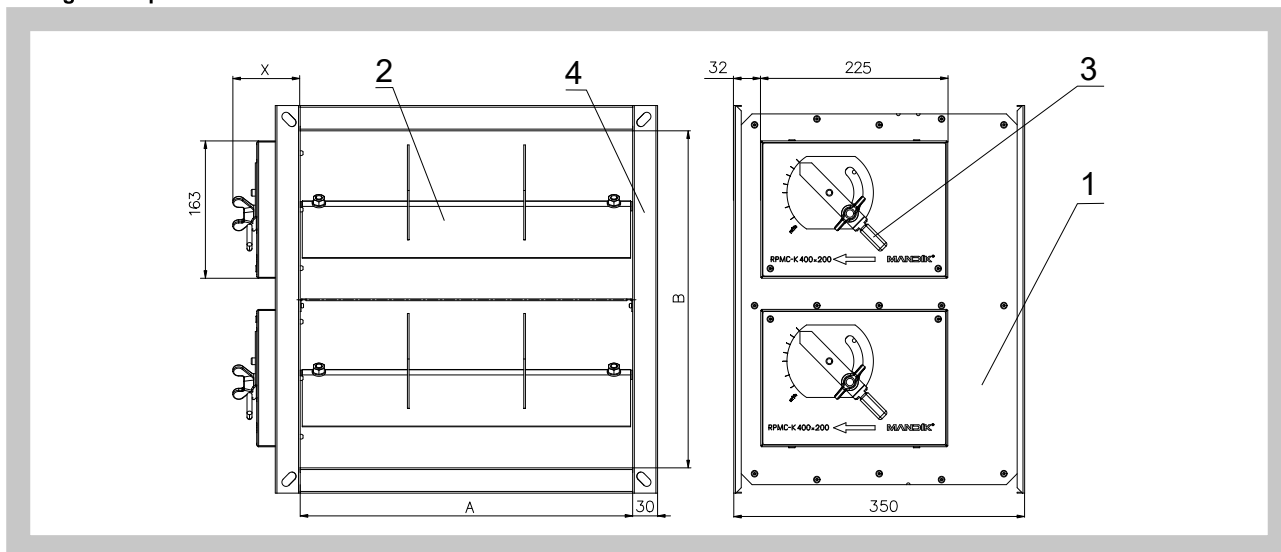

Fig. 6 Square constant air volume controller - B ≥ 400 mechanical control



Position:

- | | | |
|---------------------|----------|-----------------------|
| 1 Controller casing | 3 Lever | 5 Actuating mechanism |
| 2 Controller blade | 4 Flange | 6 Insulation cover |

Tab. 3.1.1. Dimensions and weights

Size A x B	X	Z	Weight [kg]				EI. actuating mechanism type
			Design				
			mechanical		actuating mechanism		
			without insulation	with insulation	without insulation	with insulation	
200 x 100	62	125	3,97	6,10	4,63	6,76	LM
200 x 150	62	125	4,36	6,74	5,01	7,40	LM
200 x 200	62	125	4,79	7,43	5,45	8,09	LM
300 x 100	62	125	4,69	7,32	5,35	7,98	LM
300 x 150	62	125	5,15	8,03	5,80	8,69	LM
300 x 200	62	125	5,55	8,68	6,21	9,34	LM
300 x 250	62	125	5,96	9,35	6,62	10,01	NM
300 x 300	81	132	6,47	10,11	7,43	11,07	NM
400 x 200	81	132	6,38	10,02	7,04	10,68	LM
400 x 250	87	137	6,88	10,77	7,84	11,73	NM
400 x 300	81	132	7,93	12,06	8,88	13,02	NM
400 x 400	*81	132	10,70	15,34	12,61	17,25	NM
500 x 200	81	132	7,19	11,32	8,15	12,28	NM
500 x 250	87	137	8,77	13,15	9,73	14,11	NM
500 x 300	120	170	9,95	14,58	11,10	15,74	SM
500 x 400	*81	132	12,00	17,14	13,92	19,06	NM
500 x 500	*87	137	15,17	20,81	17,08	22,72	NM
600 x 200	120	170	9,60	14,23	10,75	15,39	SM
600 x 250	120	170	10,26	15,15	11,42	16,31	SM
600 x 300	120	170	10,88	16,02	12,04	17,18	SM
600 x 400	*120	170	16,48	22,12	18,80	24,44	SM
600 x 500	*120	170	17,81	23,95	20,13	26,27	SM
600 x 600	*120	170	19,06	25,70	21,37	28,01	SM

* From B ≥ 400 are controllers assembled from two equal units placed in one case - side to side. Requested air volume is sum of air volume for each controller. Controllers are equipped by two mechanical control or two actuating mechanisms.

4. Placement and Assembly

- 4.1. Controllers are intended for installation in ventilation ducts. Operating position is horizontal or vertical with horizontal blade axis.

The controller has to be installed in the direction of air flow. Air flow direction is marked with an arrow on the control panel device.

For faultless functioning, the air circulation in the whole controller section has to be secured as steady on whole surface. Distance between controller and duct elements (bends, double branch joints etc.) has to be minimal 2 x U (double branch joint) and 1 x U (bend).

- 4.2. The controller body should not be deformed in the course of installation.

Fig. 7 Recommended distance from double branch joint

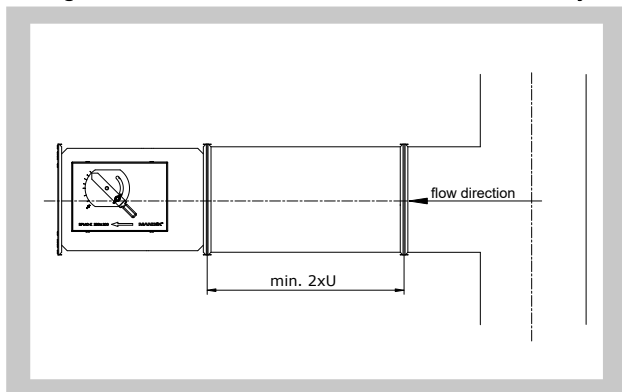
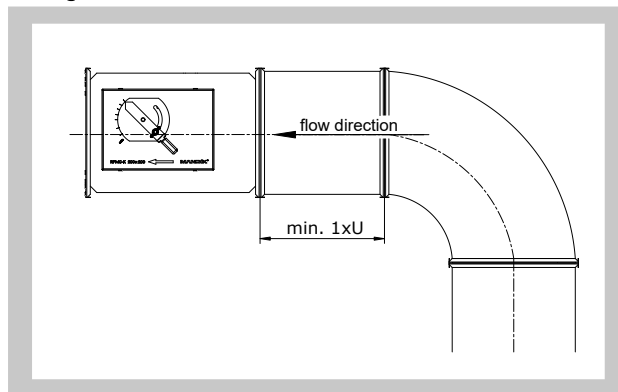

Fig. 8 Recommended distance from bend



* U - diagonal

4.3. Flanges of square controllers are 30 mm wide with oval hole

Fig. 9 Flange

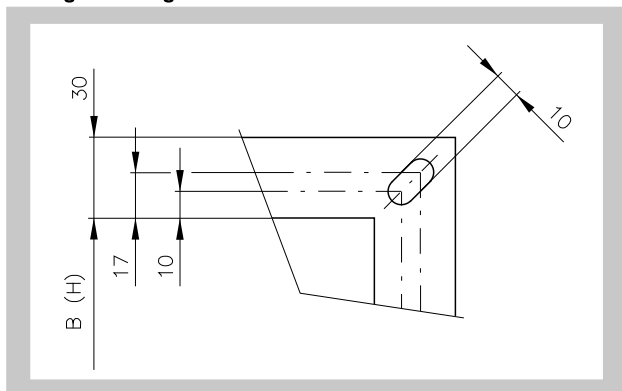

III. TECHNICAL DATA

5. Basic parameters

5.1. Air volume

Tab. 5.1.1. Air volume

Size A x B	Air volume [m ³ .h ⁻¹]		Size A x B	Air volume [m ³ .h ⁻¹]	
	minimal	maximal		minimal	maximal
200 x 100	250	700	500 x 200	1100	3400
200 x 150	400	1000	500 x 250	1500	4200
200 x 200	500	1300	500 x 300	1800	4800
300 x 100	400	1000	500 x 400	2200	6800
300 x 150	500	1500	500 x 500	3000	8400
300 x 200	600	2000	600 x 200	1500	4000
300 x 250	800	2500	600 x 250	1800	5000
300 x 300	1000	3000	600 x 300	2100	6000
400 x 200	900	2700	600 x 400	3000	8000
400 x 250	1200	3400	600 x 500	3600	10000
400 x 300	1500	4200	600 x 600	4200	12000
400 x 400	1800	5400			

5.2. Controller parameters

Tab. 5.2.1. Controller parameters

Size	Air volume (m ³ /h)	Max. accuracy (%)	Min. press. difference (Pa)	Size	Air volume (m ³ /h)	Max. accuracy (%)	Min. press. difference (Pa)
200x100	250	20	70	300x150	500	20	70
	400	15	70		800	15	70
	500	15	70		1000	10	70
	700	10	80		1500	10	70
200x150	400	20	70	300x200	600	20	70
	600	15	70		800	15	70
	800	15	70		1200	15	80
	1000	10	80		2000	10	80
200x200	500	20	70	300x250	800	20	70
	700	15	70		1200	15	70
	1000	10	70		1700	10	80
	1300	10	80		2500	10	80
300x100	400	20	70	300x300	1000	20	70
	600	15	70		1500	15	70
	800	10	70		2000	15	80
	1000	10	80		3000	10	90
400x200	900	20	70	500x500	3000	20	70
	1500	15	70		5000	15	70
	2000	10	70		7000	15	80
	2700	10	70		8400	10	90
400x250	1200	20	70	600x200	1500	20	70
	1600	15	70		2000	15	70
	2500	15	70		3000	15	70
	3400	10	80		4000	10	80
400x300	1500	20	70	600x250	1800	20	70
	2500	15	70		2500	15	70
	3500	15	70		3500	15	80
	4200	10	90		5000	10	80
400x400	1800	20	70	600x300	2100	20	70
	3000	15	70		3500	15	70
	4000	10	70		4500	10	80
	5400	10	70		6000	10	80
500x200	1100	20	70	600x400	3000	20	70
	1500	15	70		4000	15	70
	2500	15	70		6000	15	70
	3400	10	80		8000	10	80
500x250	1500	20	70	600x500	3600	20	70
	2500	15	70		5000	15	70
	3500	15	80		7000	15	80
	4200	10	90		10000	10	80
500x300	1800	20	70	600x600	4200	20	70
	2500	15	70		7000	15	70
	3500	15	80		9000	10	80
	4800	10	90		12000	10	80
500x400	2200	20	70				
	3000	15	70				
	5000	15	70				
	6800	10	80				

6. Elektrical components, wiring diagrams

6.1. Parameters of actuating mechanisms

Tab. 6.1.1. Parameters of actuating

Actuating mechanism	Position indication	Torque	Weight [kg]	Nominal voltage	Power consumption		
					In operation	At rest	Dimensioning
Belimo LM 230A	NO	5 Nm	0,50	AC 100 ... 240 V, 50/60 Hz	1,5 W	0,4 W	4 VA
Belimo LM 230A-S	YES	5 Nm	0,60	AC 100 ... 240 V, 50/60 Hz	1,5 W	0,4 W	4 VA
Belimo NM 230A	NO	10 Nm	0,75	AC 100 ... 240 V, 50/60 Hz	2,5 W	0,6 W	5,5 VA
Belimo NM 230A-S	YES	10 Nm	0,85	AC 100 ... 240 V, 50/60 Hz	2,5 W	0,6 W	6 VA
Belimo LM 24A	NO	5 Nm	0,50	AC 24 V, 50/60 Hz; DC 24 V	1 W	0,2 W	2 VA
Belimo LM 24A-S	YES	5 Nm	0,60	AC 24 V, 50/60 Hz; DC 24 V	1 W	0,2 W	2 VA
Belimo NM 24A	NO	10 Nm	0,75	AC 24 V, 50/60 Hz; DC 24 V	1,5 W	0,2 W	3,5 VA
Belimo NM 24A-S	YES	10 Nm	0,85	AC 24 V, 50/60 Hz; DC 24 V	1,5 W	0,2 W	4 VA
Belimo LM 24A-SR	YES	5 Nm	0,85	AC 24 V, 50/60 Hz; DC 24 V	1,0 W	0,4 W	2 VA
Belimo NM 24A-SR	YES	10 Nm	0,80	AC 24 V, 50/60 Hz; DC 24 V	2,0 W	0,4 W	4 VA
Belimo SM 230A	NO	20 Nm	1,05	AC 100 ... 240 V, 50/60 Hz	2,5 W	0,6 W	6 VA
Belimo SM 230A-S	YES	20 Nm	1,10	AC 100 ... 240 V, 50/60 Hz	2,5 W	0,6 W	6 VA
Belimo SM 24A	NO	20 Nm	1,00	AC 24 V, 50/60 Hz; DC 24 V	2,0 W	0,2 W	4 VA
Belimo SM 24A-S	YES	20 Nm	1,05	AC 24 V, 50/60 Hz; DC 24 V	2,0 W	0,2 W	4 VA
Belimo SM 24A-SR	YES	20 Nm	1,05	AC 24 V, 50/60 Hz; DC 24 V	2,0 W	0,4 W	4 VA

6.2. Wiring diagrams

Fig. 10 Wiring diagram - actuating mechanism Belimo LM(NM, SM) 230A

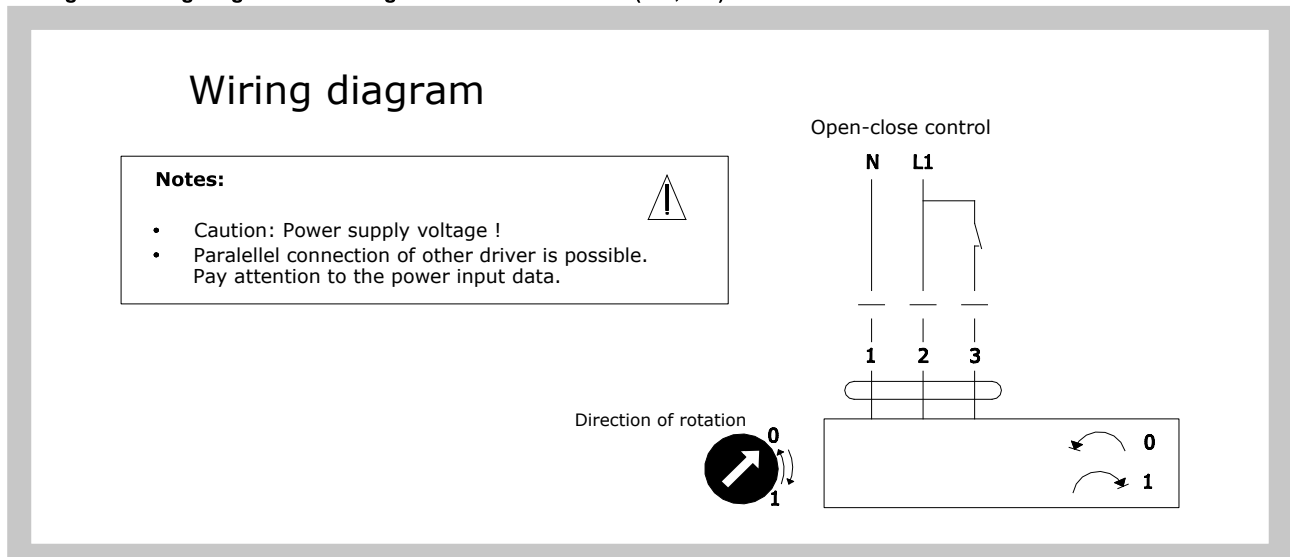

Fig. 11 Wiring diagram - actuating mechanism Belimo LM(NM, SM) 24A

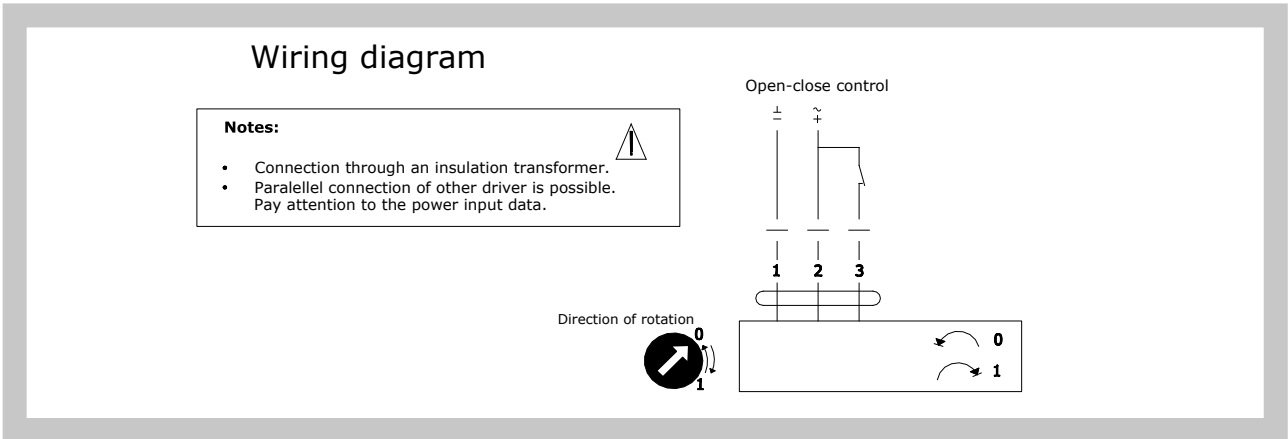

Fig. 12 Wiring diagram - actuating mechanism Belimo NM (SM) 24A-SR

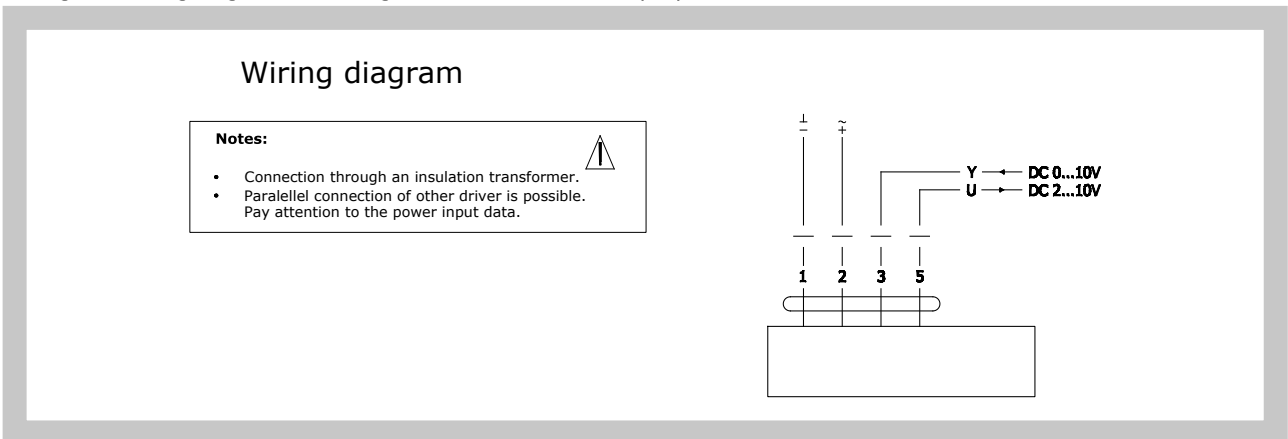

Fig. 13 Wiring diagram - actuating mechanism Belimo LM(NM, SM) 230A-S

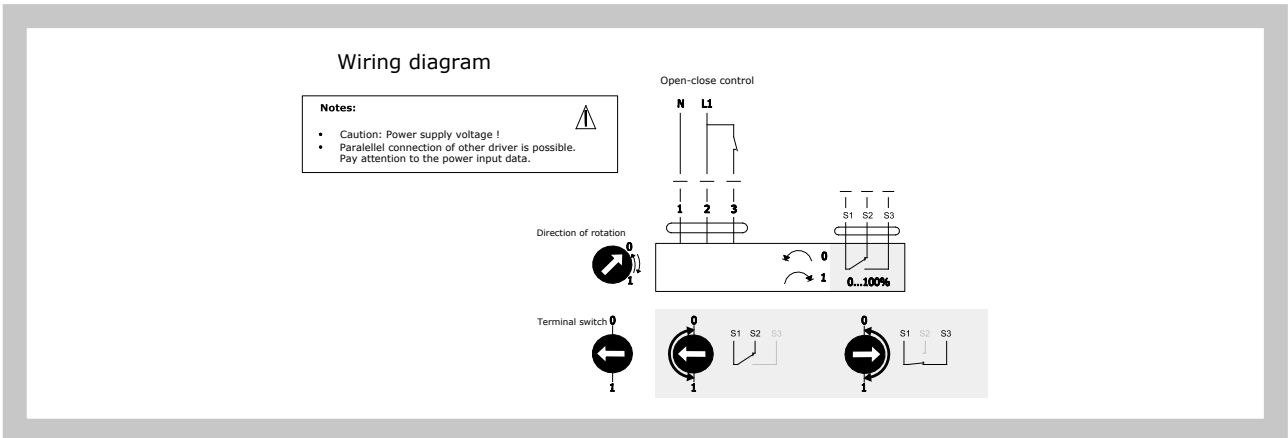
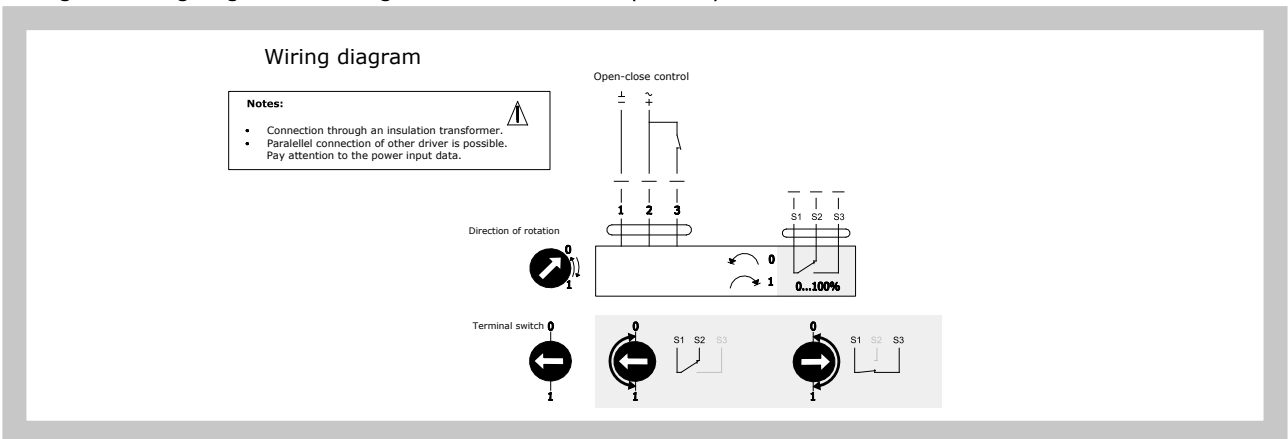

Fig. 14 Wiring diagram - actuating mechanism Belimo LM(NM, SM) 24A-S



7. Pressure loss

7.1. Pressure losses

$$\Delta p = \xi \cdot \rho \cdot \frac{w^2}{2}$$

Δp [Pa] pressure loss
 w [m.s⁻¹] air flow speed in nominal controller section
 ρ [kg.m⁻³] air density
 ξ [-] coefficient of local pressure loss for the nominal controller section (see Tab. 7.1.1.)

Tab. 7.1.1. Coefficient of local pressure loss ξ (the values are valid when the damper of the controller is completely open)

Size A x B	ξ	Size A x B	ξ	Size A x B	ξ
200 x 100	1,386	400 x 200	1,344	500 x 500	1,224
200 x 150	1,379	400 x 250	1,330	600 x 200	1,316
200 x 200	1,372	400 x 300	1,316	600 x 250	1,295
300 x 100	1,379	400 x 400	1,288	600 x 300	1,274
300 x 150	1,368	500 x 200	1,330	600 x 400	1,231
300 x 200	1,358	500 x 250	1,312	600 x 500	1,189
300 x 250	1,347	500 x 300	1,295	600 x 600	1,147
300 x 300	1,337	500 x 400	1,260		

Diagram 7.1.1. Pressure losses (the values are valid when the damper of the controller is completely open)

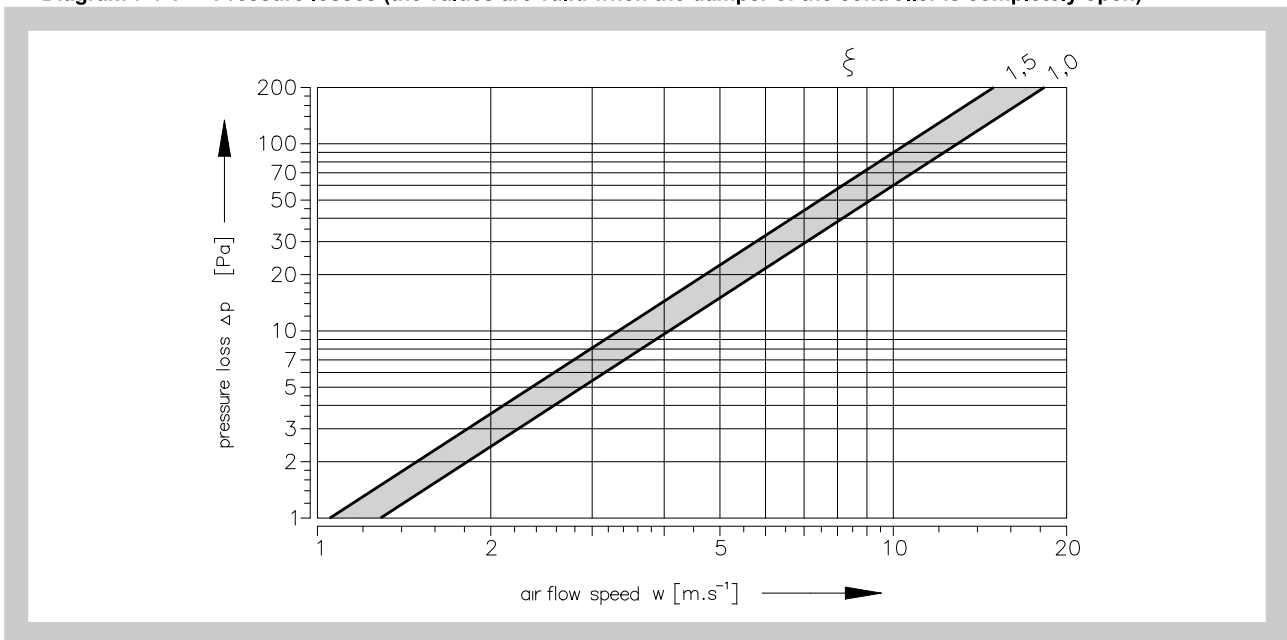

8. Noise data

8.1. Air-regenerated Noise

The noise arising due to the flow of air volume controller is listed in the following tables Tab. 8.1.1.

- \dot{V} [m³.h⁻¹] - air flow volume
- Δp_{st} [Pa] - pressure differential
- L_W [dB/Okt.] - level of acoustic power in the octave band
- L_{WA} [dB(A)] - total level of acoustic power corrected by filter A
- f_m [Hz] - mean frequencies in the octave bands

Tab. 8.1.1.

$\Delta p_{st} = 50 \text{ Pa}$										
Size	\dot{V} [m ³ /h]	LW [dB/Okt]								L _{WA} [dB(A)]
		f _m [Hz]								
		63	125	250	500	1000	2000	4000	8000	
200 x 100	250	39	38	34	34	35	36	35	33	42
	400	44	43	41	40	39	41	41	38	47
	550	43	45	44	43	45	43	44	40	50
	700	47	46	47	47	48	46	47	41	53
200 x 150	400	42	41	37	37	37	38	38	35	44
	600	44	43	42	43	42	42	42	39	49
	800	45	46	45	45	46	45	46	43	52
	1000	49	49	48	48	49	48	48	44	55
200 x 200	500	42	41	37	37	37	38	38	35	44
	765	45	44	42	41	40	42	42	39	48
	1035	44	46	47	46	46	44	44	38	51
	1300	47	46	47	48	48	47	47	39	54
300 x 100	400	45	44	40	40	40	41	41	38	47
	600	48	47	45	44	43	45	45	42	51
	800	48	50	51	50	50	48	48	42	55
	1000	51	50	51	52	52	51	51	43	58
300 x 150	500	42	41	37	37	37	38	38	35	44
	835	46	45	43	42	41	43	43	40	49
	1165	47	49	50	49	49	47	47	41	54
	1500	51	50	51	52	52	51	51	43	58
300 x 200	600	44	43	39	39	39	40	40	37	46
	1065	47	46	44	43	42	44	44	41	50
	1535	47	49	50	49	49	47	47	41	54
	2000	52	51	52	53	53	52	52	44	59
300 x 250	800	45	44	40	40	40	41	41	38	47
	1365	49	47	45	44	43	45	45	42	51
	1935	48	50	51	50	50	48	48	42	55
	2500	51	50	51	52	52	51	51	43	58
300 x 300	1000	45	44	40	40	40	41	41	38	47
	4665	48	47	45	44	43	45	45	42	51
	2335	48	50	51	50	50	48	48	42	55
	3000	51	50	51	52	52	51	51	43	58
400 x 200	900	45	44	40	40	40	41	41	38	47
	1500	47	46	44	44	42	44	44	41	50
	2100	47	49	50	49	49	47	47	41	54
	2700	50	49	50	51	51	50	50	42	57
400 x 250	1200	46	45	41	41	40	42	42	39	48
	1935	48	47	45	44	43	45	45	42	51
	2665	47	49	50	49	49	47	47	41	54
	3400	50	49	50	51	51	50	50	42	57
400 x 300	1500	47	46	42	42	41	43	43	40	49
	2400	49	48	46	45	44	46	46	43	52
	3300	49	51	52	51	51	49	49	43	56
	4200	53	52	53	54	54	53	53	45	60
400 x 400	1800	48	48	44	44	43	45	45	42	51
	3000	51	50	48	47	46	48	48	45	54
	4200	50	52	53	52	52	50	50	44	57
	5400	55	54	55	56	56	55	55	47	62

$\Delta p_{st} = 50 \text{ Pa}$										
Size	V [m³/h]	LW [dB/Okt]								L _{WA} [dB(A)]
		fm [Hz]								
		63	125	250	500	1000	2000	4000	8000	
500 x 200	1100	43	42	38	38	37	39	39	36	45
	1865	45	43	42	41	39	42	42	39	48
	2635	44	46	47	46	46	44	44	38	51
	3400	48	47	48	49	49	48	48	40	55
500 x 250	1500	45	44	40	40	39	41	41	38	47
	2400	48	47	45	44	42	45	45	42	51
	3300	47	49	50	49	49	47	47	41	54
	4200	49	48	49	50	50	49	49	41	56
500 x 300	1800	46	45	41	41	40	42	42	39	48
	2800	48	47	45	44	42	45	45	42	51
	3800	48	50	51	50	50	48	48	42	55
	4800	51	50	51	52	52	51	51	43	58
500 x 400	2200	51	50	46	46	45	47	47	44	53
	3735	54	53	51	50	47	51	51	48	57
	5265	53	55	56	55	55	53	53	47	60
	6800	56	55	56	57	57	56	56	48	63
500 x 500	3000	53	52	48	48	48	49	49	46	55
	4800	56	55	53	52	49	53	53	50	59
	6600	55	57	58	57	57	55	55	49	62
	8400	58	57	58	59	59	58	58	50	65
600 x 200	1500	43	42	39	39	39	40	40	37	46
	2335	47	45	43	42	40	43	43	40	49
	3165	46	48	49	48	48	46	46	40	53
	4000	49	48	49	50	50	49	49	41	56
600 x 250	1800	45	45	41	41	41	42	42	39	48
	2865	48	47	45	44	42	45	45	42	51
	3935	47	49	50	49	49	47	47	41	54
	5000	50	49	50	51	51	50	50	42	57
600 x 300	2100	48	47	43	43	43	44	44	41	50
	3400	49	48	46	45	44	46	46	43	52
	4700	48	50	51	50	50	48	48	42	55
	6000	51	50	51	52	52	51	51	43	58
600 x 400	3000	51	50	46	46	46	47	47	44	53
	4665	53	52	50	49	48	50	50	47	56
	6335	53	55	56	55	55	53	53	47	60
	8000	55	54	55	56	56	55	55	47	62
600 x 500	3600	53	52	48	48	48	49	49	46	55
	5735	56	55	53	52	51	53	53	50	59
	7865	55	57	58	57	57	55	55	49	62
	10000	58	57	58	59	59	58	58	50	65
600 x 600	4200	56	55	51	51	51	52	52	49	58
	6800	58	57	55	54	53	55	55	52	61
	9400	57	59	60	59	59	57	57	51	64
	12000	59	58	59	60	60	59	59	51	66

$\Delta p_{st} = 100 \text{ Pa}$										
Size	\dot{V} [m³/h]	L _w [dB/Okt]								L _{WA} [dB(A)]
		f _m [Hz]								
		63	125	250	500	1000	2000	4000	8000	
200 x 100	250	46	45	41	41	41	42	42	39	48
	400	49	48	46	45	44	46	46	43	52
	550	50	50	51	50	50	48	48	43	55
	700	52	51	53	52	52	51	51	45	58
200 x 150	400	46	45	42	42	42	43	43	39	49
	600	50	49	47	46	45	47	46	43	53
	800	51	51	52	51	51	49	49	43	56
	1000	52	51	52	53	53	52	52	44	59
200 x 200	500	48	47	43	43	43	44	44	41	50
	765	50	49	47	46	45	47	47	44	53
	1035	49	51	52	51	51	49	49	43	56
	1300	52	51	52	53	53	52	52	44	59
300 x 100	400	49	48	44	44	44	45	45	42	51
	600	51	50	48	47	46	48	48	45	54
	800	51	53	54	53	53	51	51	45	58
	1000	54	53	54	55	55	54	54	46	61
300 x 150	500	47	46	42	42	42	43	43	40	49
	835	51	50	48	47	46	48	48	45	54
	1165	52	54	55	54	54	52	52	46	59
	1500	57	55	56	57	57	56	56	48	63
300 x 200	600	50	49	45	45	45	46	46	43	52
	1065	53	52	50	49	48	50	50	47	56
	1535	53	55	56	55	55	53	53	47	60
	2000	57	56	57	58	58	57	57	49	64
300 x 250	800	51	50	46	46	46	47	47	44	53
	1365	55	53	51	50	49	51	51	48	57
	1935	53	55	56	55	55	53	53	47	60
	2500	56	55	56	57	57	56	56	48	63
300 x 300	1000	51	50	46	46	46	47	47	44	53
	4665	54	53	51	50	49	51	51	48	57
	2335	54	55	56	55	55	53	53	47	60
	3000	56	55	56	57	57	56	56	48	63
400 x 200	900	51	50	46	46	46	47	47	44	53
	1500	53	52	50	49	48	50	50	47	56
	2100	52	54	55	54	54	52	52	46	59
	2700	55	54	55	56	56	55	55	47	62
400 x 250	1200	52	51	47	47	47	48	48	45	54
	1935	54	53	51	50	49	51	51	48	57
	2665	53	55	56	55	55	53	53	47	60
	3400	55	54	55	56	56	55	55	47	62
400 x 300	1500	53	52	48	48	48	49	49	46	55
	2400	55	54	52	51	50	52	52	49	58
	3300	55	57	58	57	57	55	55	49	62
	4200	59	58	59	60	60	59	59	51	66
400 x 400	1800	55	54	50	50	50	51	51	48	57
	3000	57	56	54	53	52	54	54	51	60
	4200	56	58	59	58	58	56	56	50	63
	5400	60	59	60	61	61	60	60	52	67

$\Delta p_{st} = 100 \text{ Pa}$										
Size	V [m³/h]	L _w [dB/Okt]								L _{WA} [dB(A)]
		f _m [Hz]								
		63	125	250	500	1000	2000	4000	8000	
500 x 200	1100	49	48	44	44	44	45	45	42	51
	1865	51	50	48	47	46	48	48	45	54
	2635	50	52	53	52	52	50	50	44	57
	3400	53	52	53	54	54	53	53	45	60
500 x 250	1500	51	50	46	46	46	47	47	44	53
	2400	53	52	50	49	48	50	50	47	56
	3300	52	54	55	54	54	52	52	46	59
	4200	54	53	54	55	55	54	54	46	61
500 x 300	1800	52	51	47	47	47	48	48	45	54
	2800	54	53	51	50	49	51	51	48	57
	3800	53	55	56	55	55	53	53	47	60
	4800	56	55	56	57	57	56	56	48	63
500 x 400	2200	56	55	51	51	51	52	52	49	58
	3735	59	58	56	55	54	56	56	53	62
	5265	58	60	61	60	60	58	58	52	65
	6800	61	60	61	62	62	61	61	53	68
500 x 500	3000	58	57	53	53	53	54	54	51	60
	4800	61	60	58	57	56	58	58	55	64
	6600	60	62	63	62	62	60	60	54	67
	8400	62	61	62	63	63	62	62	54	69
600 x 200	1500	50	49	45	45	45	46	46	43	52
	2335	53	51	49	48	47	49	49	46	55
	3165	51	53	54	53	53	51	51	45	58
	4000	54	53	54	55	55	54	54	46	61
600 x 250	1800	52	51	47	47	47	48	48	45	54
	2865	54	53	51	50	49	51	51	48	57
	3935	54	55	56	55	55	53	53	47	60
	5000	57	55	56	57	57	56	56	48	63
600 x 300	2100	53	52	48	48	48	49	49	46	55
	3400	55	54	52	51	50	52	52	49	58
	4700	54	56	57	56	56	54	54	48	61
	6000	56	55	56	57	57	56	56	48	63
600 x 400	3000	57	56	52	52	52	53	53	50	59
	4665	59	58	56	55	54	56	56	53	62
	6335	58	60	61	60	60	58	58	52	65
	8000	60	59	60	61	61	60	60	52	67
600 x 500	3600	59	58	54	54	54	55	55	52	61
	5735	61	60	58	57	56	58	58	55	64
	7865	60	62	63	62	62	60	60	54	67
	10000	63	62	63	64	64	63	63	55	70
600 x 600	4200	61	60	56	56	56	57	57	54	63
	6800	63	62	60	59	58	60	60	57	66
	9400	62	64	65	64	64	62	62	56	69
	12000	63	62	63	64	64	63	63	55	70

$\Delta p_{st} = 250 \text{ Pa}$										
Size	V [m³/h]	L _w [dB/Okt]								L _{WA} [dB(A)]
		f _m [Hz]								
		63	125	250	500	1000	2000	4000	8000	
200 x 100	250	54	53	49	49	49	50	50	47	56
	400	57	56	54	53	52	54	54	51	60
	550	56	58	59	58	58	56	56	52	63
	700	59	58	59	60	60	59	59	53	66
200 x 150	400	55	54	50	50	50	51	52	49	58
	600	58	57	55	54	53	55	55	52	61
	800	57	58	60	58	59	57	57	51	64
	1000	60	59	61	61	61	60	59	53	67
200 x 200	500	56	55	51	51	51	52	52	49	58
	765	58	57	55	54	53	55	55	52	61
	1035	57	59	60	59	59	57	57	51	64
	1300	60	59	60	61	61	60	60	52	67
300 x 100	400	56	55	51	51	51	52	52	49	58
	600	58	57	55	54	53	55	55	52	61
	800	57	59	60	59	59	57	57	51	64
	1000	60	59	60	61	61	60	60	52	67
300 x 150	500	56	55	51	51	51	52	52	49	58
	835	59	58	56	55	54	56	56	53	62
	1165	59	61	62	61	61	59	59	53	66
	1500	62	61	62	63	63	62	62	54	69
300 x 200	600	59	58	54	54	54	55	55	52	61
	1065	61	60	58	57	56	58	58	55	64
	1535	61	63	64	63	63	61	61	55	68
	2000	64	63	64	65	65	64	64	56	71
300 x 250	800	60	59	55	55	55	56	56	53	62
	1365	62	61	59	58	57	59	59	56	65
	1935	61	63	64	63	63	61	61	55	68
	2500	64	63	64	65	65	64	64	56	71
300 x 300	1000	61	60	56	56	56	57	57	54	63
	4665	63	62	60	59	58	60	60	57	66
	2335	62	64	65	64	64	62	62	56	69
	3000	65	64	65	66	66	65	65	57	72
400 x 200	900	61	60	56	56	56	57	57	54	63
	1500	62	61	59	58	57	59	59	56	65
	2100	61	63	64	63	63	61	61	55	68
	2700	63	62	63	64	64	63	63	55	70
400 x 250	1200	61	60	56	56	56	57	57	54	63
	1935	63	62	60	59	58	60	60	57	66
	2665	61	63	64	63	63	61	61	55	68
	3400	63	62	63	64	64	63	63	55	70
400 x 300	1500	62	61	57	57	57	58	58	55	64
	2400	64	63	61	60	59	61	61	58	67
	3300	64	65	66	65	65	63	63	57	70
	4200	66	65	66	67	67	66	66	58	73
400 x 400	1800	64	63	59	59	59	60	60	57	66
	3000	66	65	63	62	61	63	63	60	69
	4200	64	66	67	66	66	64	64	58	71
	5400	67	66	67	68	68	67	67	59	74

$\Delta p_{st} = 250 \text{ Pa}$										
Size	V [m³/h]	L _w [dB/Okt]								L _{WA} [dB(A)]
		f _m [Hz]								
		63	125	250	500	1000	2000	4000	8000	
500 x 200	1100	59	58	54	54	54	55	55	52	61
	1865	61	60	58	57	56	58	58	55	64
	2635	59	61	62	61	61	59	59	53	66
	3400	61	60	61	62	62	61	61	53	68
500 x 250	1500	61	60	56	56	56	57	57	54	63
	2400	62	61	59	58	57	59	59	56	65
	3300	60	62	63	62	62	60	60	54	67
	4200	62	61	62	63	63	62	62	54	69
500 x 300	1800	62	61	57	57	57	58	58	55	64
	2800	63	62	60	59	58	60	60	57	66
	3800	61	63	64	63	63	61	61	55	68
	4800	63	62	63	64	64	63	63	55	70
500 x 400	2200	65	64	60	60	60	61	61	58	67
	3735	67	66	64	63	62	64	64	61	70
	5265	66	68	69	68	68	66	66	60	73
	6800	69	68	69	70	70	69	69	61	76
500 x 500	3000	67	66	62	62	62	63	63	60	69
	4800	69	68	66	65	64	66	66	63	72
	6600	67	69	70	69	69	67	67	61	74
	8400	69	68	69	70	70	69	69	61	76
600 x 200	1500	59	58	54	54	54	55	55	52	61
	2335	61	60	58	57	56	58	58	55	64
	3165	59	61	62	61	61	59	59	53	66
	4000	62	61	62	63	63	62	62	54	69
600 x 250	1800	60	59	55	55	55	56	56	53	62
	2865	63	61	59	58	57	59	59	56	65
	3935	61	63	64	63	63	61	61	55	68
	5000	64	63	64	65	65	64	64	56	71
600 x 300	2100	62	61	57	57	57	58	58	55	64
	3400	63	62	60	59	58	60	60	57	66
	4700	61	63	64	63	63	61	61	55	68
	6000	63	62	63	64	64	63	63	55	70
600 x 400	3000	65	64	60	60	60	61	61	58	67
	4665	67	66	64	63	62	64	64	61	70
	6335	66	68	69	68	68	66	66	60	73
	8000	68	67	68	69	69	68	68	60	75
600 x 500	3600	67	66	62	62	62	63	63	60	69
	5735	69	68	66	65	64	66	66	63	72
	7865	68	70	71	70	70	68	68	62	75
	10000	71	70	71	72	72	71	71	63	78
600 x 600	4200	70	69	65	65	65	66	66	63	72
	6800	71	70	68	67	66	68	68	65	74
	9400	69	71	72	71	71	69	69	63	76
	12000	70	69	70	71	71	70	70	62	77

$\Delta p_{st} = 500 \text{ Pa}$										
Size	V [m³/h]	L _w [dB/Okt]								L _{WA} [dB(A)]
		f _m [Hz]								
		63	125	250	500	1000	2000	4000	8000	
200 x 100	250	60	59	55	55	55	56	56	53	62
	400	63	62	60	59	58	60	60	57	66
	550	64	63	65	64	64	62	62	59	69
	700	66	65	66	67	67	66	65	61	73
200 x 150	400	62	61	57	57	56	58	57	54	64
	600	64	63	61	60	59	60	60	57	67
	800	63	65	66	65	65	63	63	57	70
	1000	66	65	67	67	67	66	66	58	73
200 x 200	500	62	61	57	57	57	58	58	55	64
	765	65	64	62	61	60	62	62	59	68
	1035	64	66	67	66	66	64	64	58	71
	1300	67	66	67	68	68	67	67	59	74
300 x 100	400	62	61	57	57	57	58	58	55	64
	600	64	63	61	60	59	61	61	58	67
	800	63	65	66	65	65	63	63	57	70
	1000	66	65	66	67	67	66	66	58	73
300 x 150	500	62	61	57	57	57	58	58	55	64
	835	65	64	62	61	60	62	62	59	68
	1165	65	67	68	67	67	65	65	59	72
	1500	68	67	68	69	69	68	68	60	75
300 x 200	600	65	64	60	60	60	61	61	58	67
	1065	68	67	65	64	63	65	65	62	71
	1535	67	69	70	69	69	67	67	61	74
	2000	70	69	70	71	71	70	70	62	77
300 x 250	800	67	66	62	62	62	63	63	60	69
	1365	69	68	66	65	64	66	66	63	72
	1935	68	70	71	70	70	68	68	62	75
	2500	71	70	71	72	72	71	71	63	78
300 x 300	1000	68	67	63	63	63	64	64	61	70
	4665	70	69	67	66	65	67	67	64	73
	2335	69	71	72	71	71	69	69	63	76
	3000	72	71	72	73	73	72	72	64	79
400 x 200	900	68	67	63	63	63	64	64	61	70
	1500	70	69	67	66	65	67	67	64	73
	2100	68	70	71	70	70	68	68	62	75
	2700	70	69	70	71	71	70	70	62	77
400 x 250	1200	67	66	62	62	65	63	63	60	70
	1935	70	69	67	66	66	67	67	64	73
	2665	68	70	71	70	66	68	68	62	75
	3400	70	69	70	71	71	70	70	62	77
400 x 300	1500	68	67	63	63	66	64	64	61	71
	2400	71	70	68	67	67	68	68	65	74
	3300	69	71	72	71	67	69	69	63	76
	4200	71	70	71	72	72	71	71	63	78
400 x 400	1800	71	69	65	65	68	66	66	63	73
	3000	73	72	70	69	69	70	70	67	76
	4200	71	73	74	73	69	71	71	65	78
	5400	73	72	73	74	74	73	73	65	80

$\Delta p_{st} = 500 \text{ Pa}$										
Size	V [m³/h]	L _w [dB/Okt]								L _{WA} [dB(A)]
		f _m [Hz]								
		63	125	250	500	1000	2000	4000	8000	
500 x 200	1100	66	65	61	61	64	62	62	59	69
	1865	67	66	64	63	66	64	64	61	71
	2635	66	68	69	68	65	66	66	60	73
	3400	69	68	69	70	66	69	69	61	75
500 x 250	1500	67	66	62	62	65	63	63	60	70
	2400	68	67	65	64	67	65	65	62	72
	3300	67	69	70	69	66	67	67	61	74
	4200	70	69	70	71	67	70	70	62	76
500 x 300	1800	68	67	63	63	66	64	64	61	71
	2800	69	68	66	65	68	66	66	63	73
	3800	68	70	71	70	67	68	68	62	75
	4800	71	70	71	72	68	71	71	63	77
500 x 400	2200	70	69	65	65	68	66	66	63	73
	3735	72	71	69	68	71	69	69	66	76
	5265	72	74	75	74	74	72	72	66	79
	6800	76	75	76	77	74	76	76	68	82
500 x 500	3000	74	73	69	69	68	70	70	67	76
	4800	75	74	72	71	74	72	72	69	79
	6600	74	76	77	76	76	74	74	68	81
	8400	77	76	77	78	75	77	77	69	83
600 x 200	1500	66	65	61	61	60	62	62	59	68
	2335	67	66	64	63	66	64	64	61	71
	3165	66	68	69	68	68	66	66	60	73
	4000	70	69	70	71	68	70	70	62	76
600 x 250	1800	67	66	62	62	61	63	63	60	69
	2865	68	67	65	64	67	65	65	62	72
	3935	68	70	71	70	70	68	68	62	75
	5000	71	70	71	72	72	71	71	63	78
600 x 300	2100	68	67	63	63	63	64	64	61	70
	3400	69	68	66	65	64	66	66	63	72
	4700	67	69	70	69	69	67	67	61	74
	6000	69	68	69	70	70	69	69	61	76
600 x 400	3000	72	71	67	67	67	68	68	65	74
	4665	74	73	71	70	69	71	71	68	77
	6335	73	75	76	75	75	73	73	67	80
	8000	75	74	75	76	76	75	75	67	82
600 x 500	3600	74	73	69	69	69	70	70	67	76
	5735	75	74	72	71	70	72	72	69	78
	7865	74	76	77	76	76	74	74	68	81
	10000	77	76	77	78	78	77	77	69	84
600 x 600	4200	76	75	71	71	71	72	72	69	78
	6800	77	76	74	73	72	74	74	71	80
	9400	75	77	78	77	77	75	75	69	82
	12000	76	75	76	77	77	76	76	68	83

Diagram No. 1 Sound power level L_{WA} [dB(A)] inside the pipeline 200x100

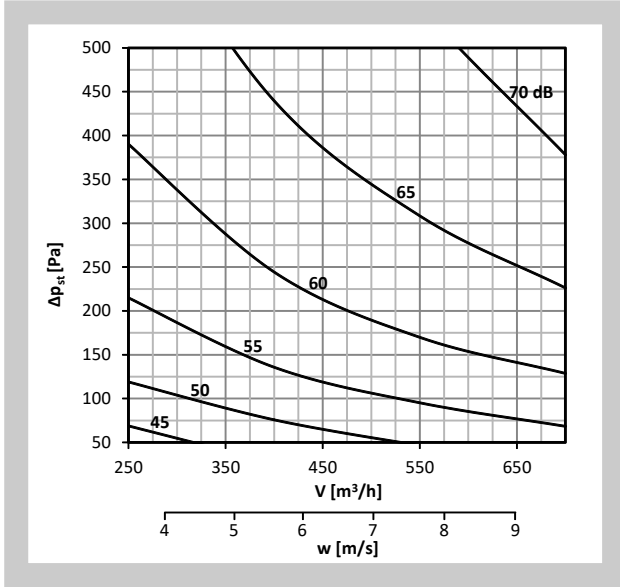

Diagram No. 2 Sound power level L_{WA} [dB(A)] inside the pipeline 200x150

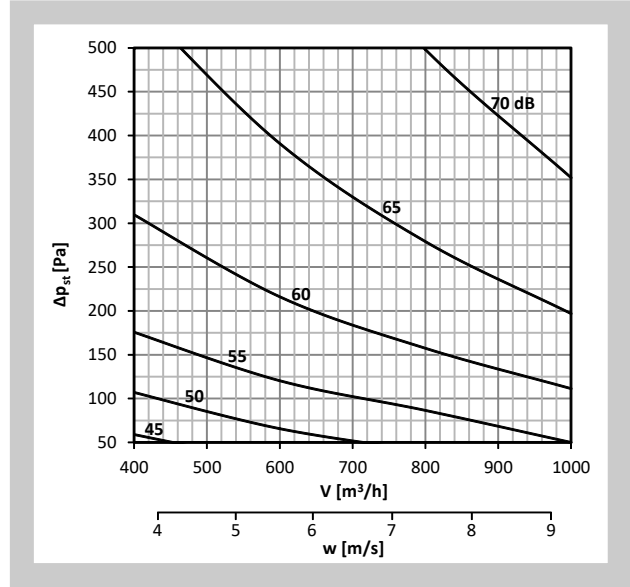

Diagram No. 3 Sound power level L_{WA} [dB(A)] inside the pipeline 200x200

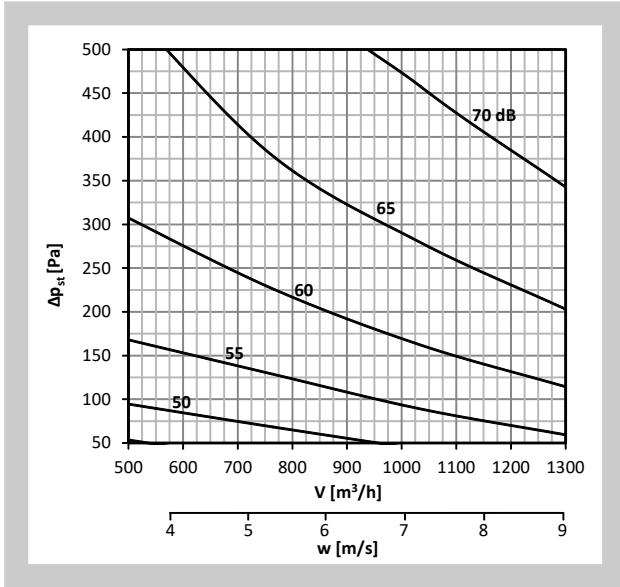

Diagram No. 4 Sound power level L_{WA} [dB(A)] inside the pipeline 300x100

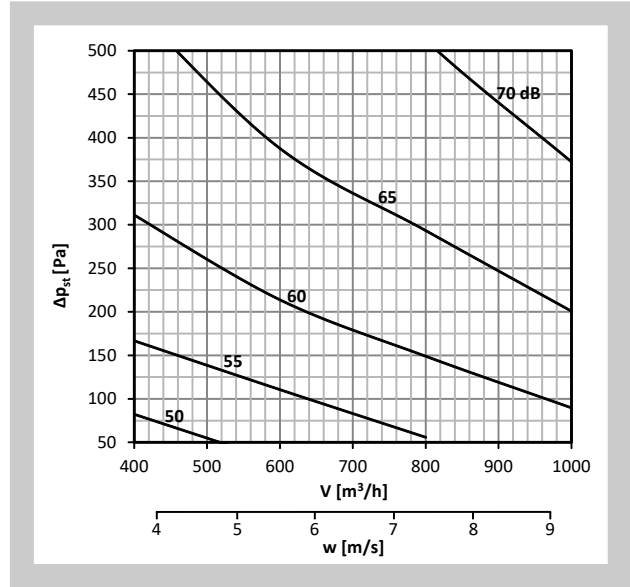

Diagram No. 5 Sound power level L_{WA} [dB(A)] inside the pipeline 300x150

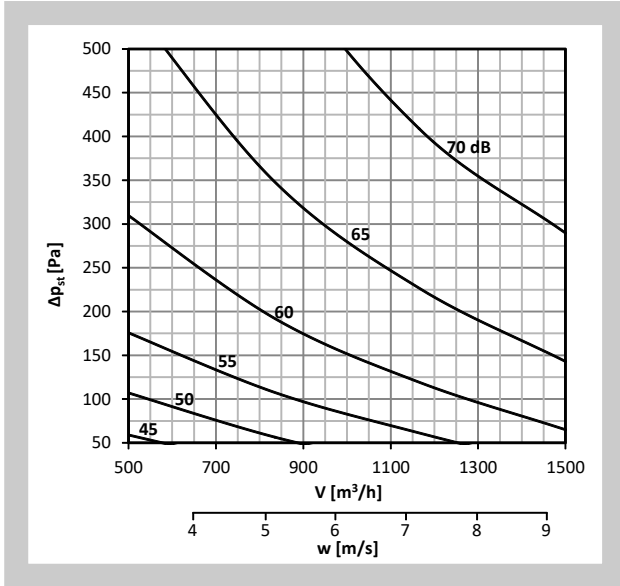

Diagram No. 6 Sound power level L_{WA} [dB(A)] inside the pipeline 300x200

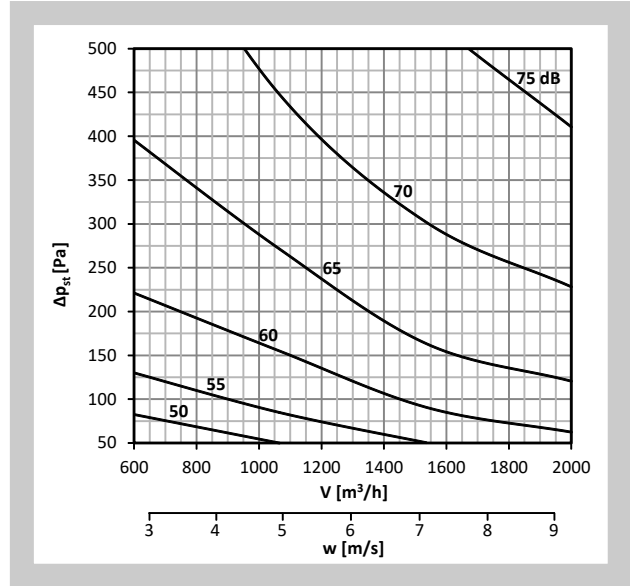

Diagram No. 7 Sound power level L_{WA} [dB(A)] inside the pipeline 300x250

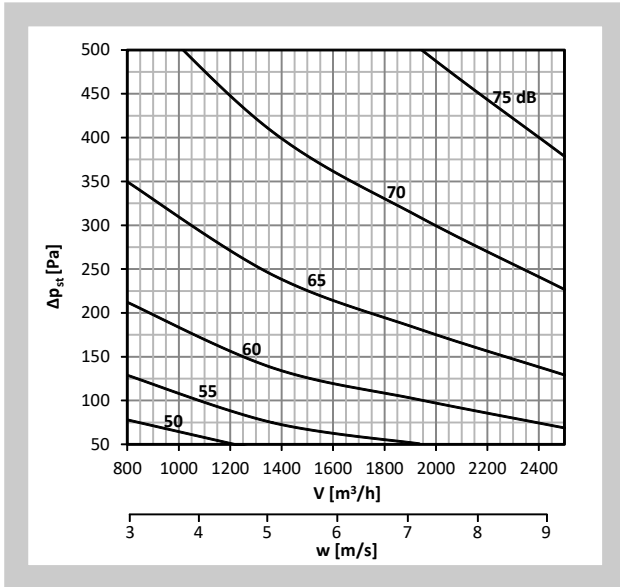

Diagram No. 8 Sound power level L_{WA} [dB(A)] inside the pipeline 300x300

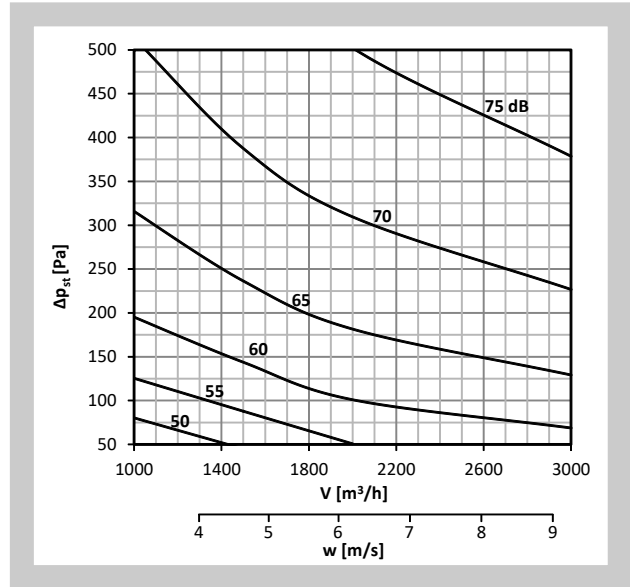

Diagram No. 9 Sound power level L_{WA} [dB(A)] inside the pipeline 400x200

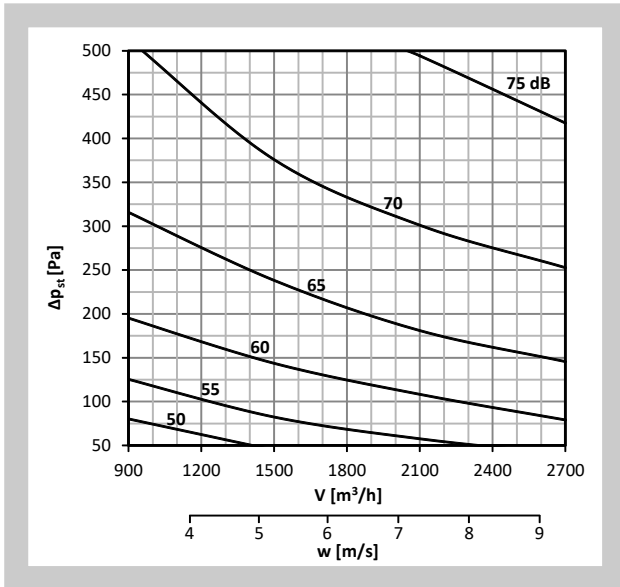

Diagram No. 10 Sound power level L_{WA} [dB(A)] inside the pipeline 400x250

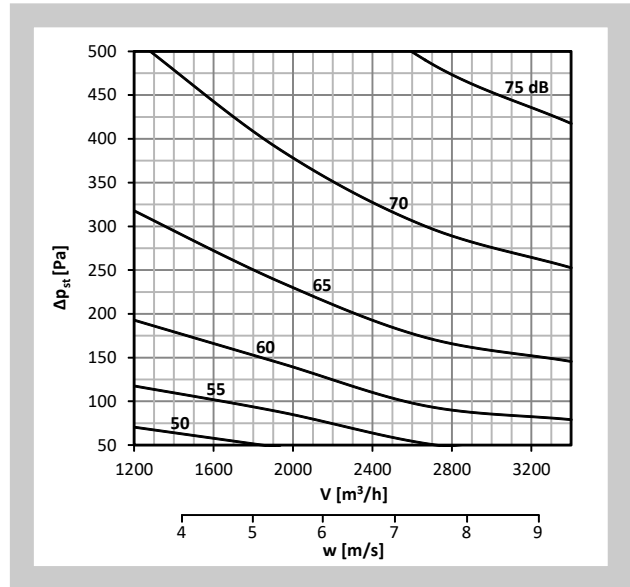

Diagram No. 11 Sound power level L_{WA} [dB(A)] inside the pipeline 400x300

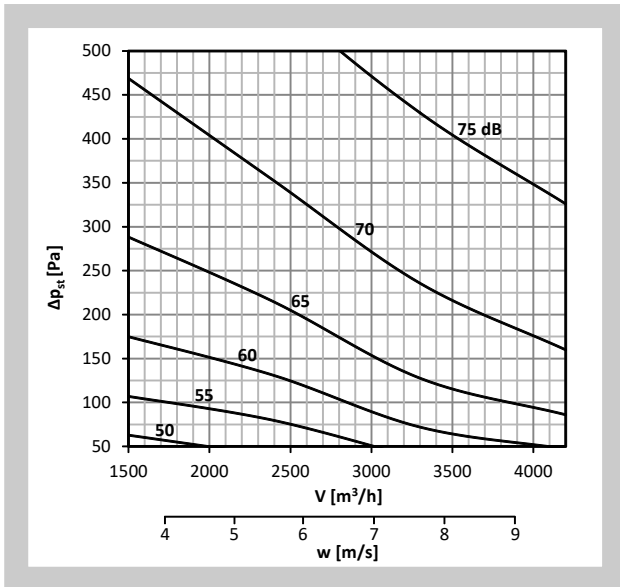

Diagram No. 12 Sound power level L_{WA} [dB(A)] inside the pipeline 400x400

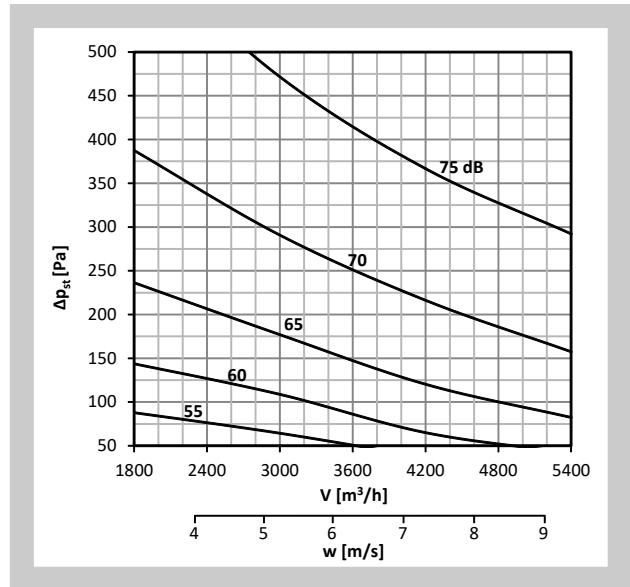

Diagram No. 13 Sound power level L_{WA} [dB(A)] inside the pipeline 500x200

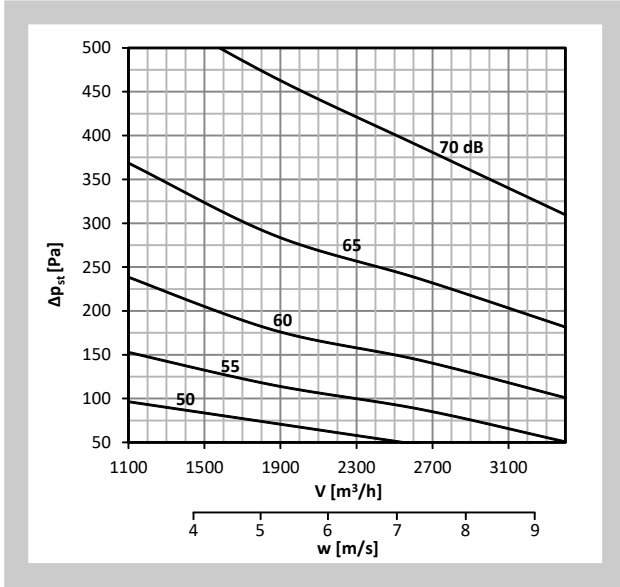

Diagram No. 14 Sound power level L_{WA} [dB(A)] inside the pipeline 500x250

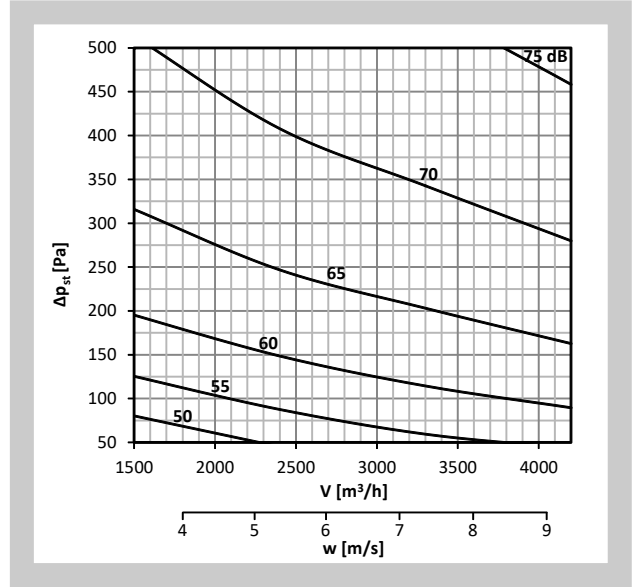

Diagram No. 15 Sound power level L_{WA} [dB(A)] inside the pipeline 500x300

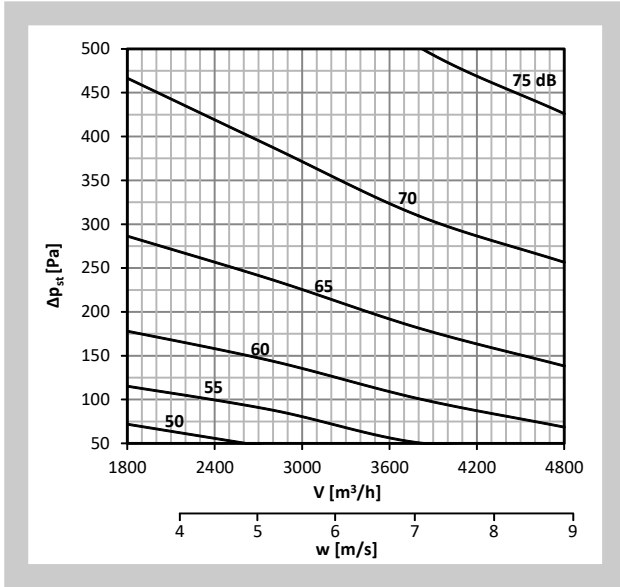

Diagram No. 16 Sound power level L_{WA} [dB(A)] inside the pipeline 500x400

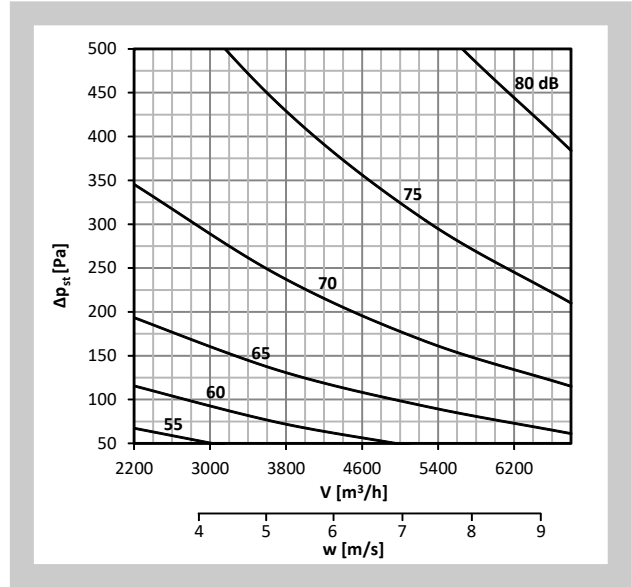

Diagram No. 17 Sound power level L_{WA} [dB(A)] inside the pipeline 500x500

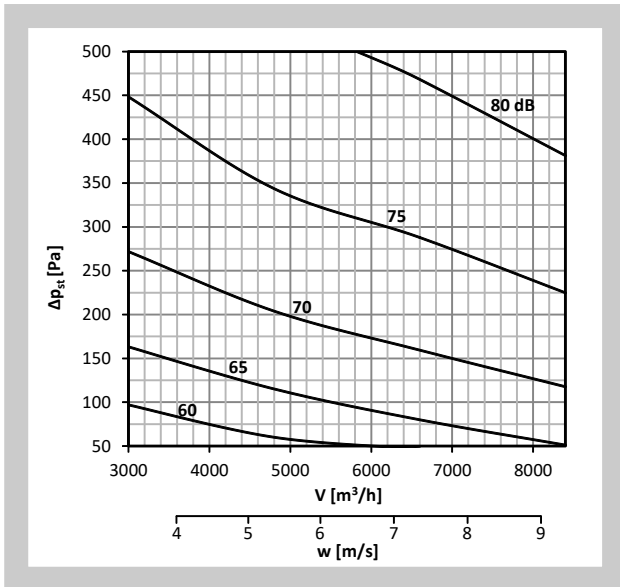

Diagram No. 18 Sound power level L_{WA} [dB(A)] inside the pipeline 600x200

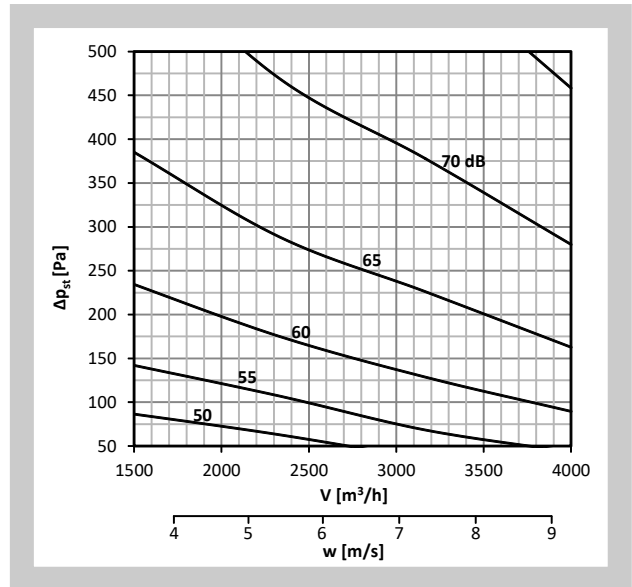

Diagram No. 19 Sound power level L_{WA} [dB(A)] inside the pipeline 600x250

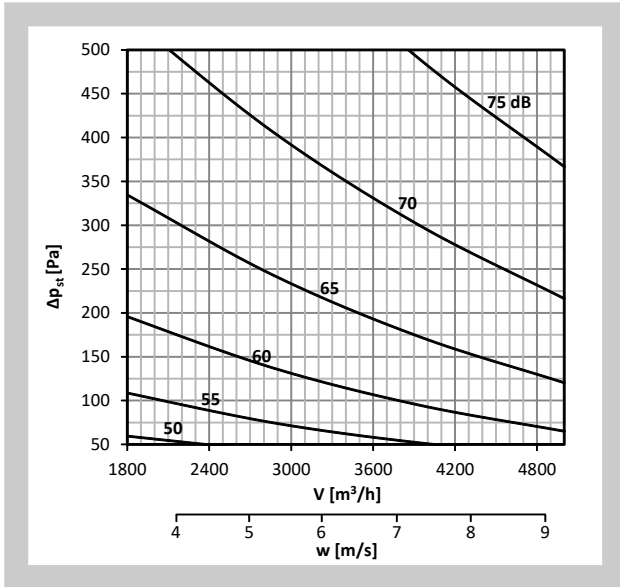

Diagram No. 20 Sound power level L_{WA} [dB(A)] inside the pipeline 600x300

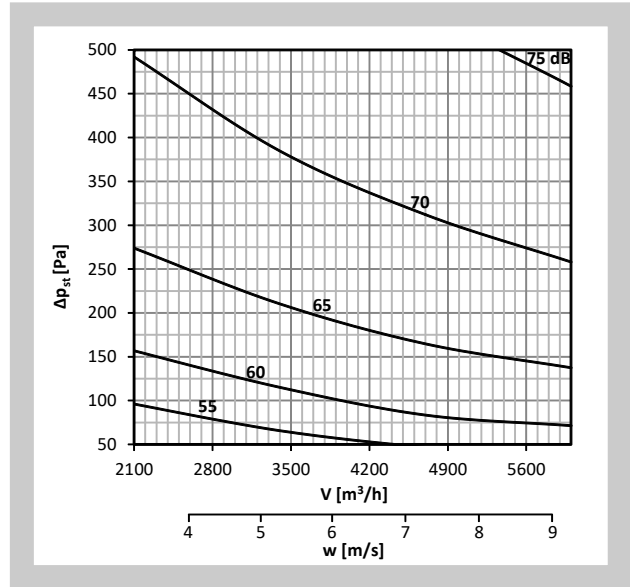

Diagram No. 21 Sound power level L_{WA} [dB(A)] inside the pipeline 600x400

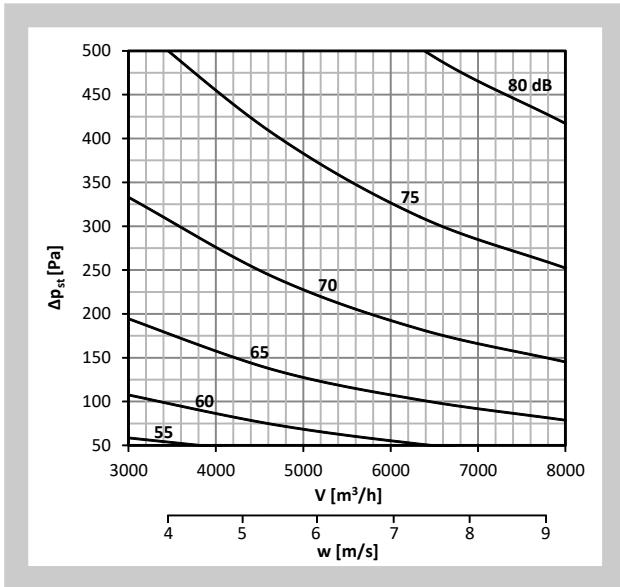

Diagram No. 22 Sound power level L_{WA} [dB(A)] inside the pipeline 600x500

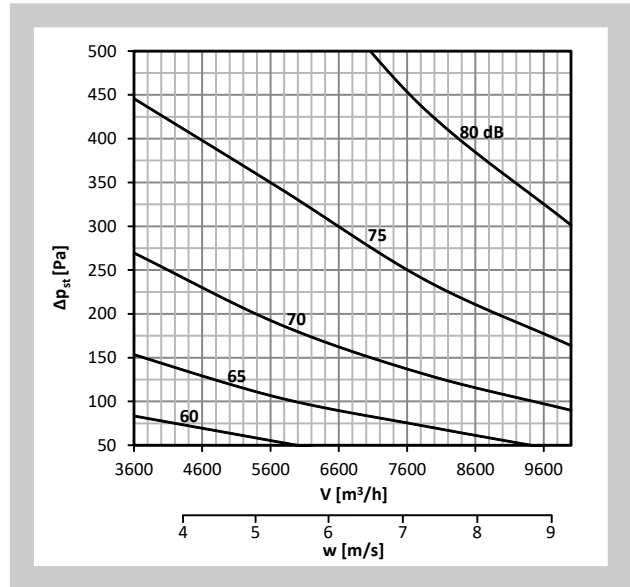
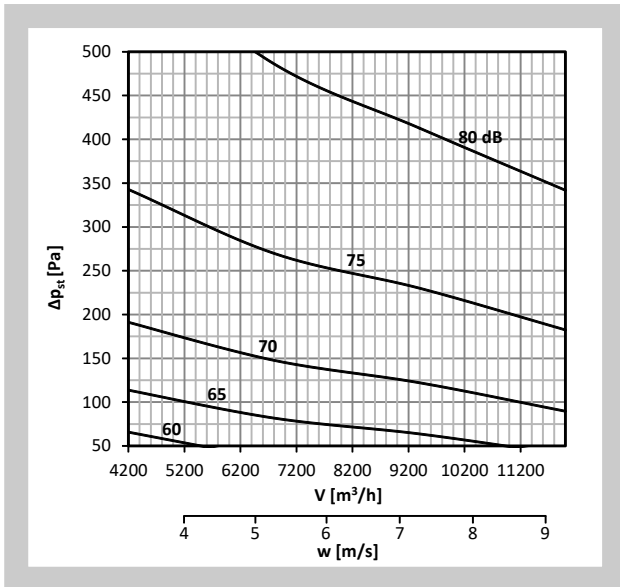

Diagram No. 23 Sound power level L_{WA} [dB(A)] inside the pipeline 600x600



8.2. Radiated noise

The radiated noise of air volume controller is listed in Tab. 8.2.1.

- \dot{V} [m³·h⁻¹] - air flow volume
 Δp_{st} [Pa] - pressure differential
 L_{WA} [dB(A)] - total level of acoustic power corrected by filter A

Tab. 8.2.1.

Size	\dot{V} [m ³ /h]	L_{WA} [dB(A)]	L_{WA} [dB(A)]	L_{WA} [dB(A)]	L_{WA} [dB(A)]
		$\Delta p_{st} = 50 \text{ Pa}$	$\Delta p_{st} = 100 \text{ Pa}$	$\Delta p_{st} = 250 \text{ Pa}$	$\Delta p_{st} = 500 \text{ Pa}$
200 x 100	250	33	39	48	55
	400	38	43	51	57
	550	42	46	53	59
	700	45	49	55	61
200 x 150	400	34	39	46	52
	600	38	42	49	55
	800	41	45	52	58
	1000	43	48	55	61
200 x 200	500	35	40	47	53
	765	40	44	51	56
	1035	43	47	54	59
	1300	45	49	56	62
300 x 100	400	36	40	46	52
	600	40	44	50	56
	800	43	47	53	59
	1000	45	49	55	61
300 x 150	500	35	39	46	52
	835	40	44	51	57
	1165	44	48	54	60
	1500	47	51	57	63
300 x 200	600	35	40	48	54
	1065	39	44	52	58
	1535	43	48	55	61
	2000	46	51	58	64
300 x 250	800	36	41	49	56
	1365	40	45	53	60
	1935	44	49	56	63
	2500	47	52	59	66
300 x 300	1000	36	41	49	57
	4665	40	45	53	61
	2335	44	49	57	64
	3000	48	53	60	67
400 x 200	900	35	40	48	55
	1500	40	45	52	59
	2100	43	48	55	61
	2700	45	50	57	63
400 x 250	1200	38	43	50	56
	1935	42	47	54	60
	2665	45	50	57	63
	3400	47	52	59	65

Size	V [m³/h]	LWA [dB(A)]	LWA [dB(A)]	LWA [dB(A)]	LWA [dB(A)]
		Δp _{st} = 50 Pa	Δp _{st} = 100 Pa	Δp _{st} = 250 Pa	Δp _{st} = 500 Pa
400 x 300	1500	39	44	52	58
	2400	43	48	56	62
	3300	46	51	59	65
	4200	48	53	61	67
400 x 400	1800	43	48	56	62
	3000	46	51	59	65
	4200	48	53	61	67
	5400	50	55	63	69
500 x 200	1100	35	40	48	55
	1865	40	45	52	58
	2635	43	48	55	61
	3400	47	51	58	63
500 x 250	1500	36	41	49	56
	2400	40	45	53	60
	3300	43	48	56	63
	4200	46	52	59	66
500 x 300	1800	38	43	51	57
	2800	42	47	55	61
	3800	44	49	58	64
	4800	47	52	60	66
500 x 400	2200	42	46	54	60
	3735	46	50	57	63
	5265	49	53	60	66
	6800	52	56	63	69
500 x 500	3000	45	50	57	63
	4800	48	53	60	66
	6600	51	56	63	68
	8400	55	59	65	70
600 x 200	1500	35	40	48	55
	2335	39	44	52	59
	3165	42	47	55	62
	4000	45	50	58	65
600 x 250	1800	36	42	50	56
	2865	40	45	53	60
	3935	43	48	56	63
	5000	46	51	59	66
600 x 300	2100	38	43	51	57
	3400	42	47	54	60
	4700	45	50	57	63
	6000	48	53	60	66
600 x 400	3000	40	45	53	60
	4665	44	49	56	63
	6335	47	52	59	65
	8000	51	55	61	67
600 x 500	3600	43	48	56	62
	5735	46	51	59	65
	7865	48	53	61	67
	10000	51	56	63	69
600 x 600	4200	45	50	57	63
	6800	48	53	60	66
	9400	51	55	62	68
	12000	53	57	64	70

Diagram No. 24 Sound power level L_{WA} [dB(A)] radiated outside the pipeline 200x100, without insulation

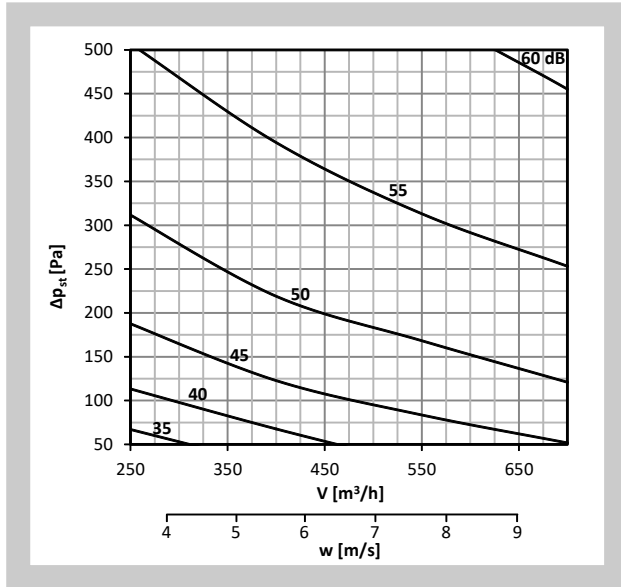

Diagram No. 25 Sound power level L_{WA} [dB(A)] radiated outside the pipeline 200x150, without insulation

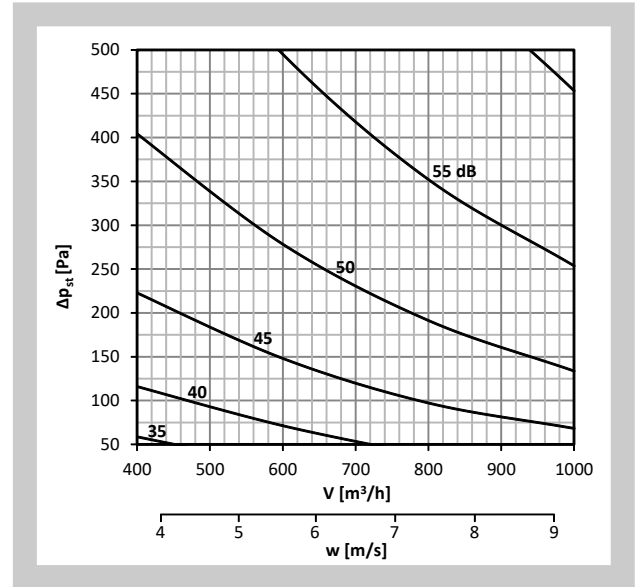

Diagram No. 26 Sound power level L_{WA} [dB(A)] radiated outside the pipeline 200x200, without insulation

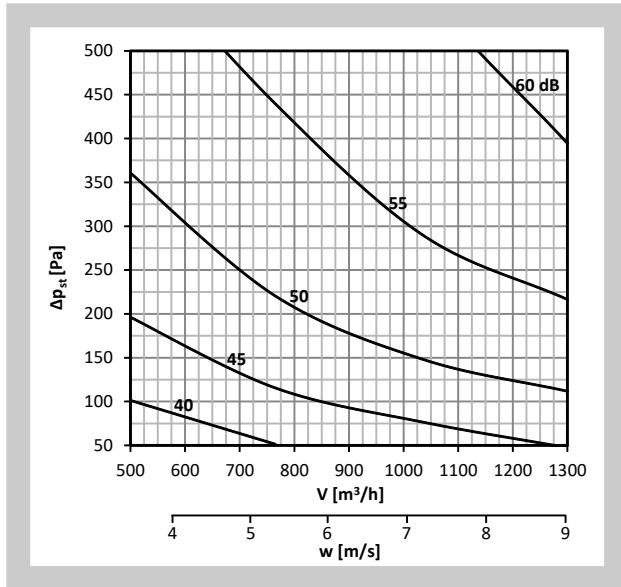

Diagram No. 27 Sound power level L_{WA} [dB(A)] radiated outside the pipeline 300x100, without insulation

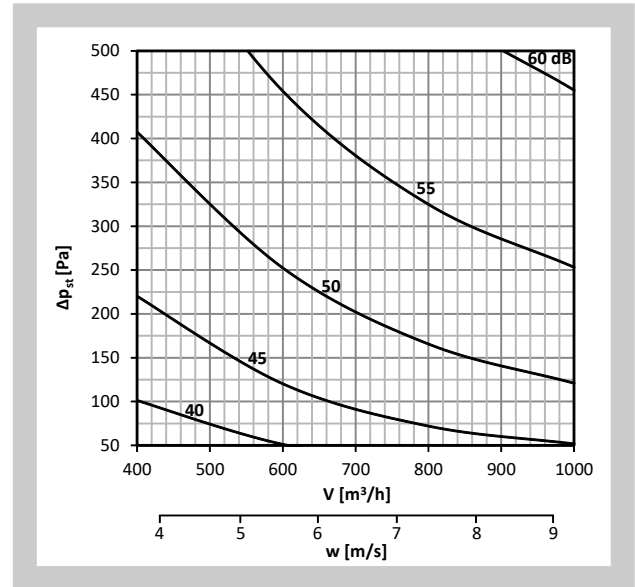

Diagram No. 28 Sound power level L_{WA} [dB(A)] radiated outside the pipeline 300x150, without insulation

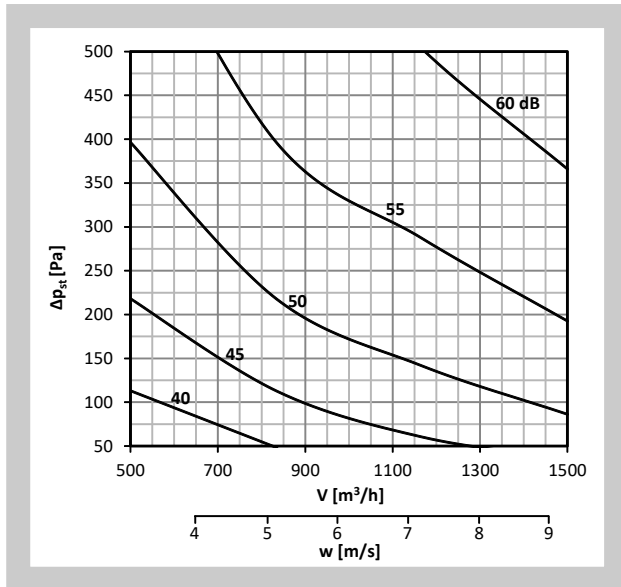

Diagram No. 29 Sound power level L_{WA} [dB(A)] radiated outside the pipeline 300x200, without insulation

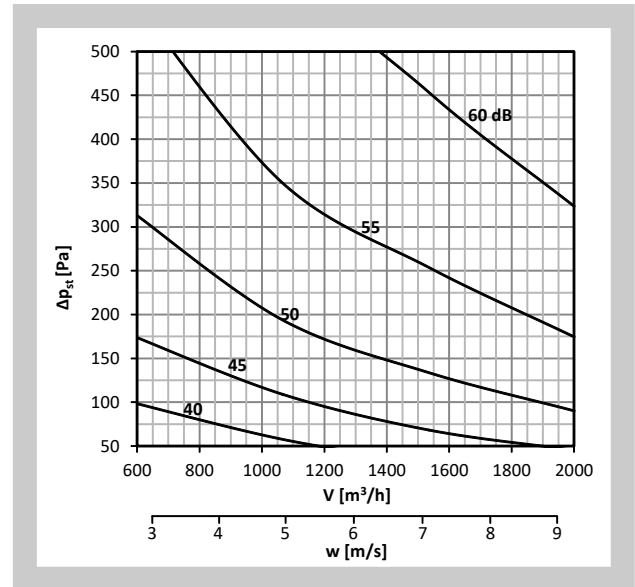

Diagram No. 30 Sound power level L_{WA} [dB(A)] radiated outside the pipeline 300x250, without insulation

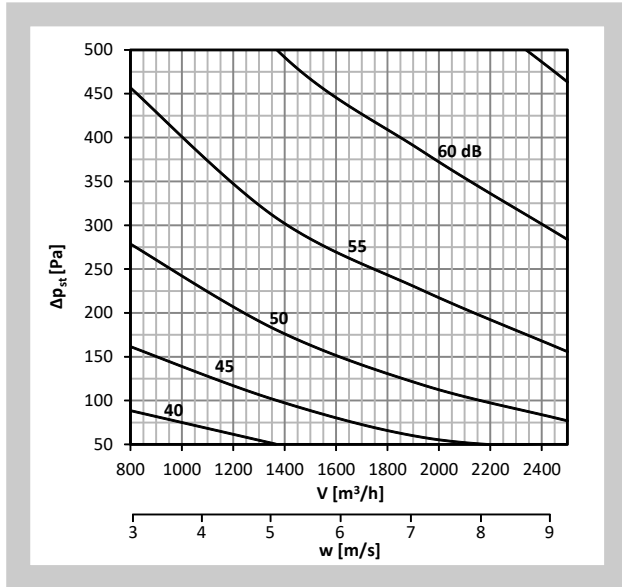

Diagram No. 31 Sound power level L_{WA} [dB(A)] radiated outside the pipeline 300x300, without insulation

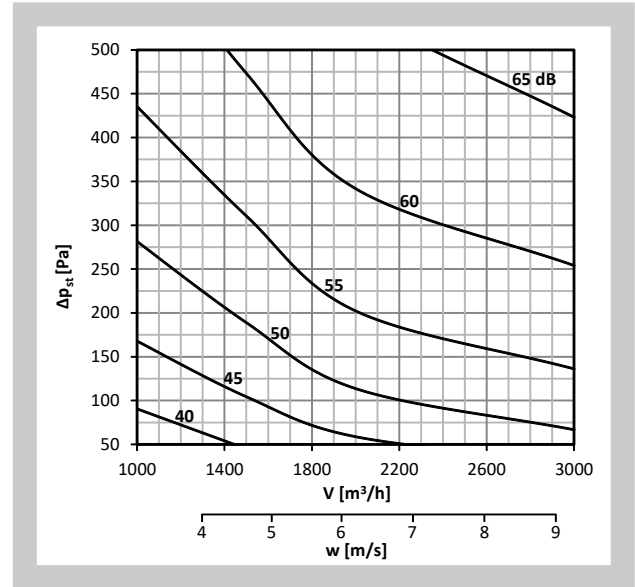

Diagram No. 32 Sound power level L_{WA} [dB(A)] radiated outside the pipeline 400x200, without insulation

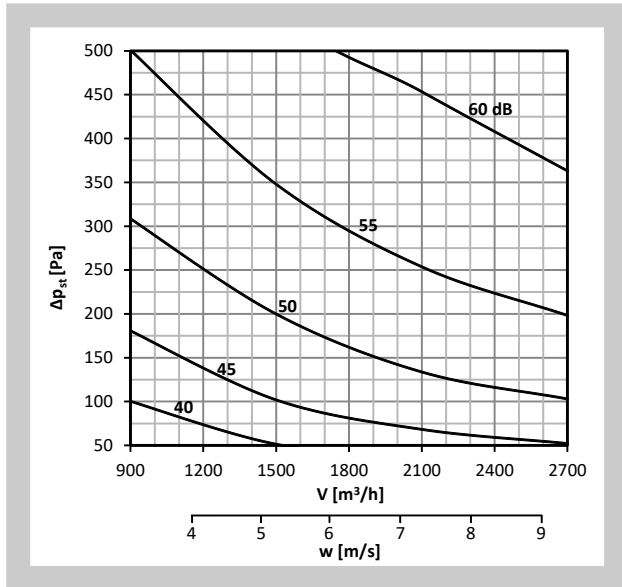

Diagram No. 33 Sound power level L_{WA} [dB(A)] radiated outside the pipeline 400x250, without insulation

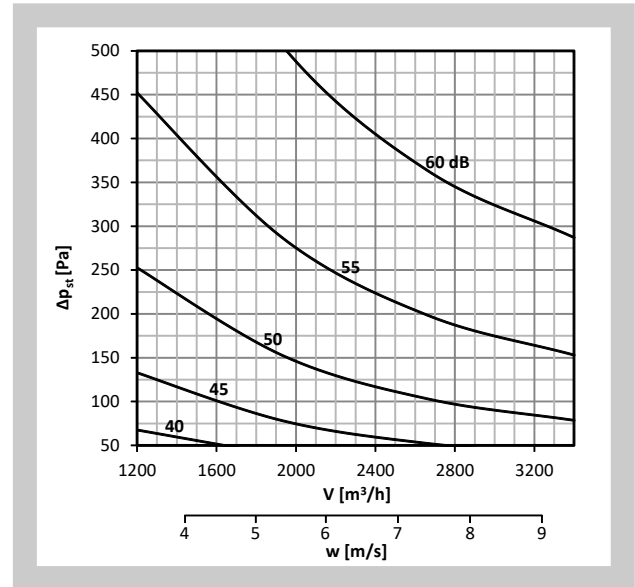

Diagram No. 34 Sound power level L_{WA} [dB(A)] radiated outside the pipeline 400x300, without insulation

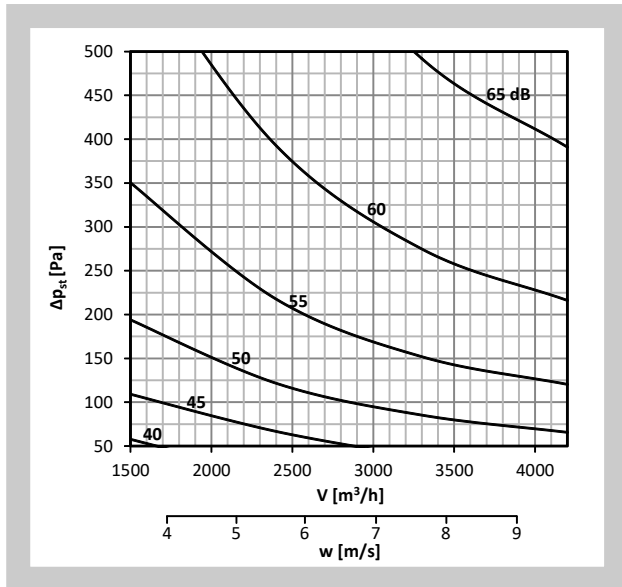

Diagram No. 35 Sound power level L_{WA} [dB(A)] radiated outside the pipeline 400x400, without insulation

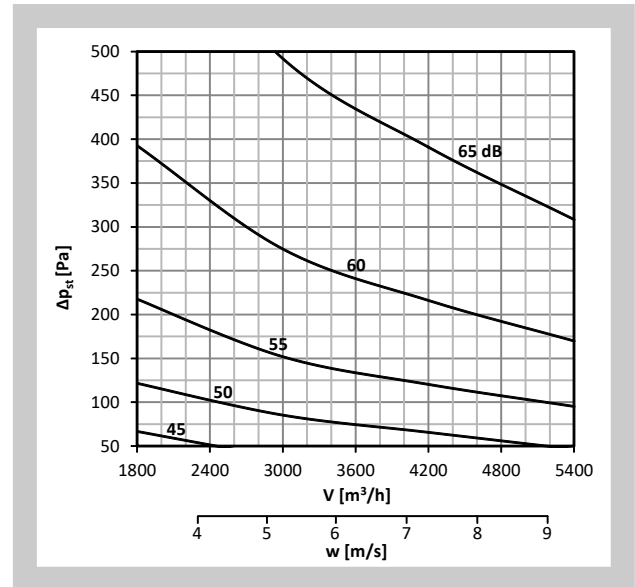

Diagram No. 36 Sound power level L_{WA} [dB(A)] radiated outside the pipeline 500x200, without insulation

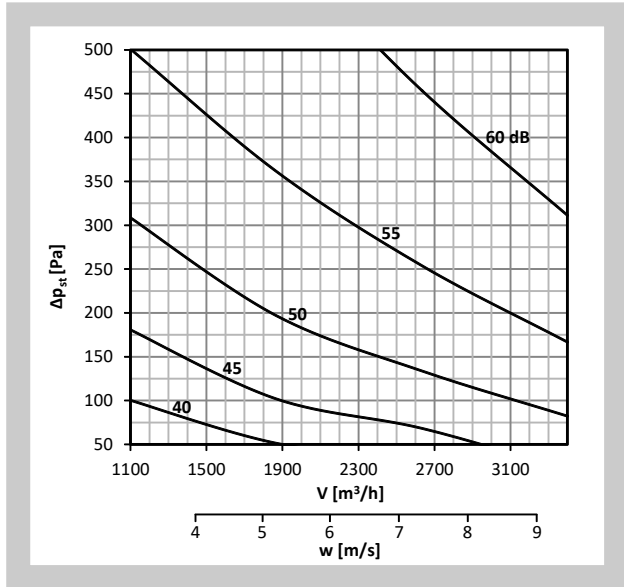

Diagram No. 37 Sound power level L_{WA} [dB(A)] radiated outside the pipeline 500x250, without insulation

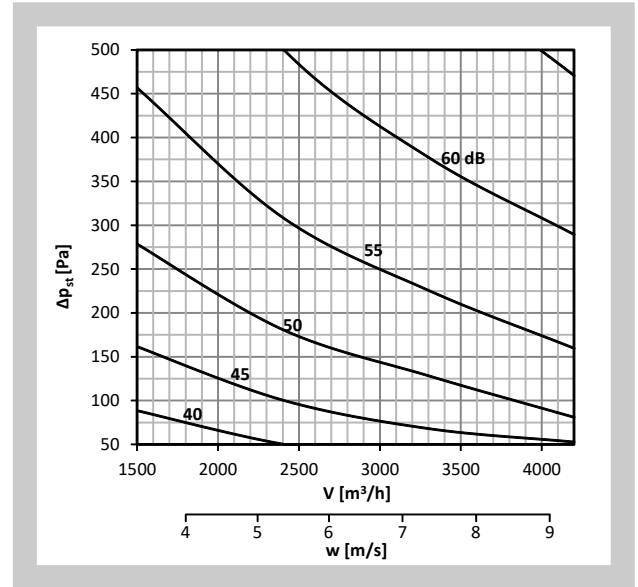

Diagram No. 38 Sound power level L_{WA} [dB(A)] radiated outside the pipeline 500x300, without insulation

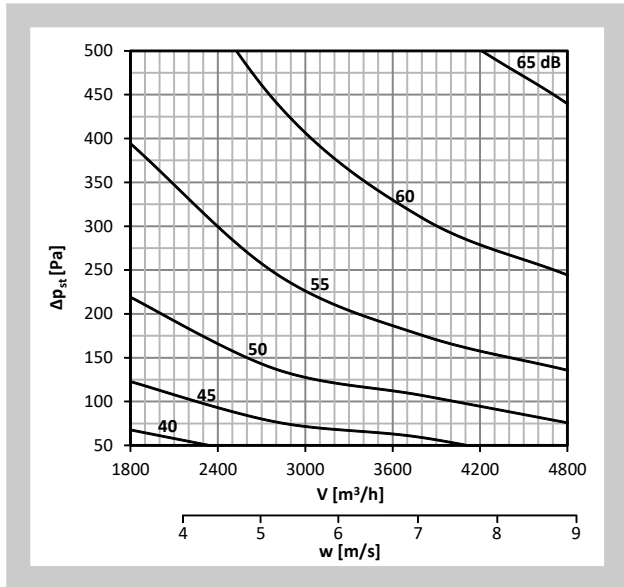

Diagram No. 39 Sound power level L_{WA} [dB(A)] radiated outside the pipeline 500x400, without insulation

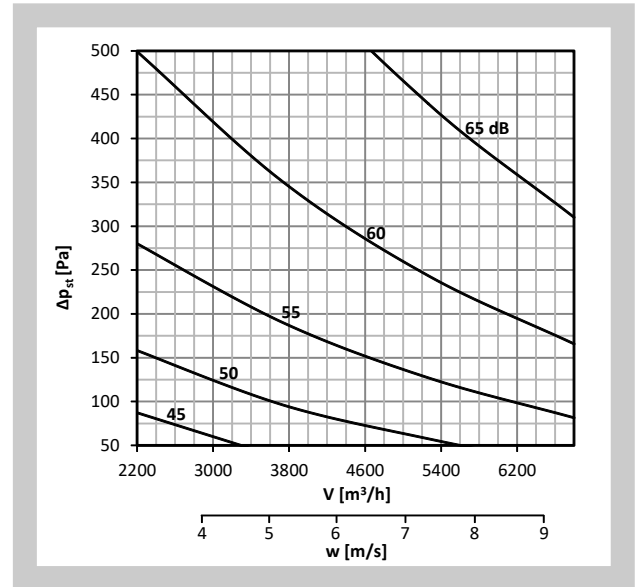

Diagram No. 40 Sound power level L_{WA} [dB(A)] radiated outside the pipeline 500x500, without insulation

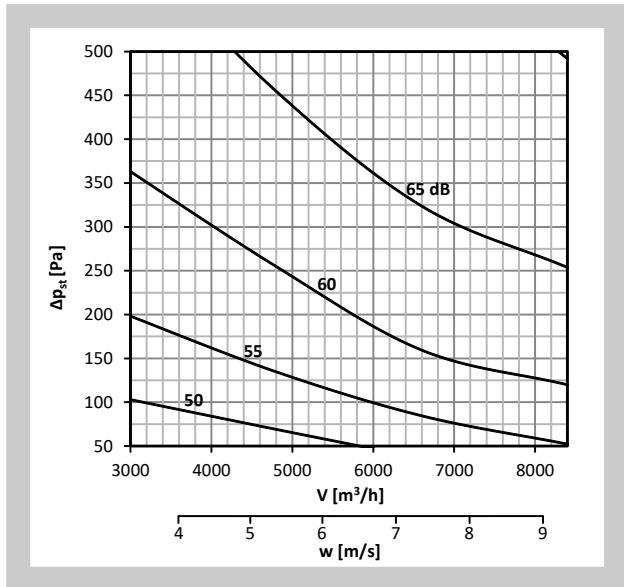

Diagram No. 41 Sound power level L_{WA} [dB(A)] radiated outside the pipeline 600x200, without insulation

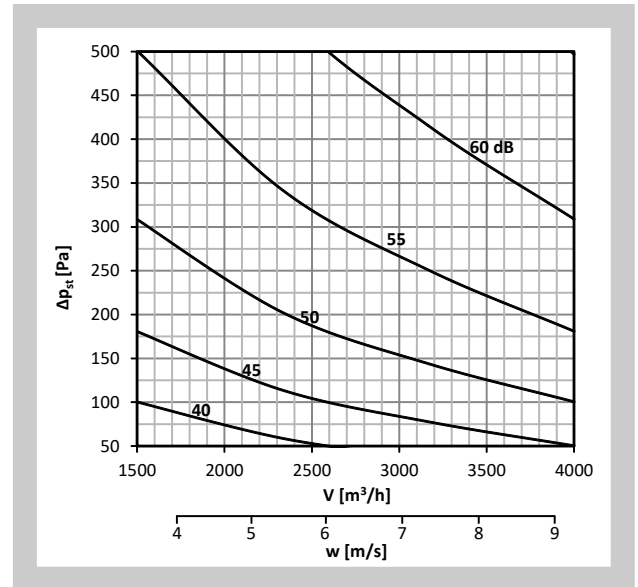

Diagram No. 42 Sound power level L_{WA} [dB(A)] radiated outside the pipeline 600x250, without insulation

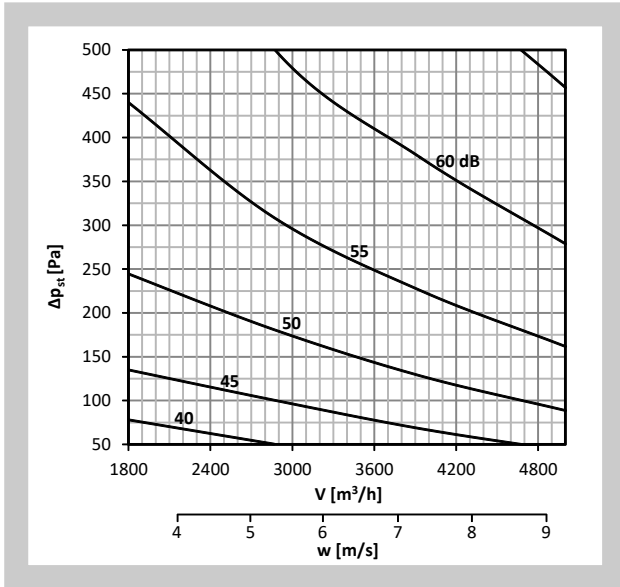

Diagram No. 43 Sound power level L_{WA} [dB(A)] radiated outside the pipeline 600x300, without insulation

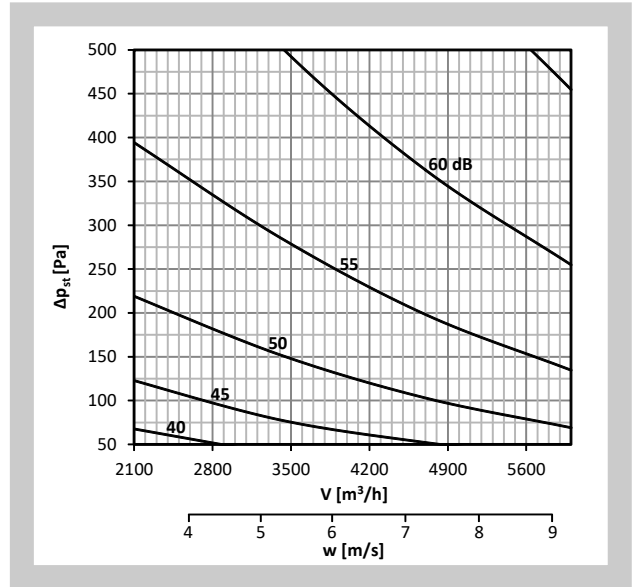

Diagram No. 44 Sound power level L_{WA} [dB(A)] radiated outside the pipeline 600x400, without insulation

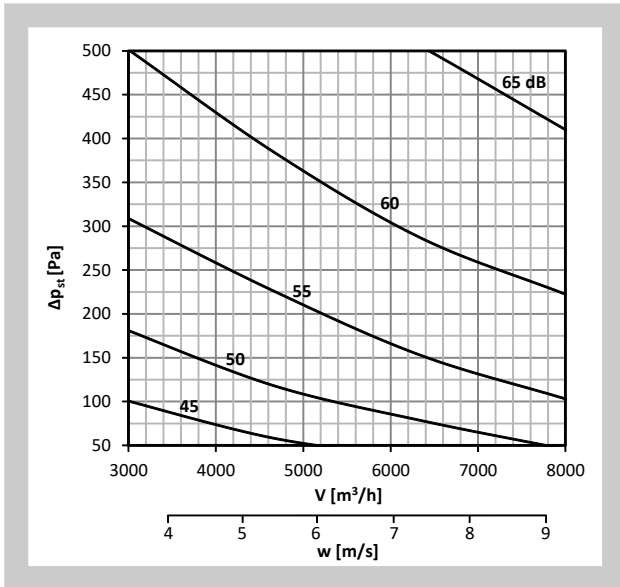

Diagram No. 45 Sound power level L_{WA} [dB(A)] radiated outside the pipeline 600x500, without insulation

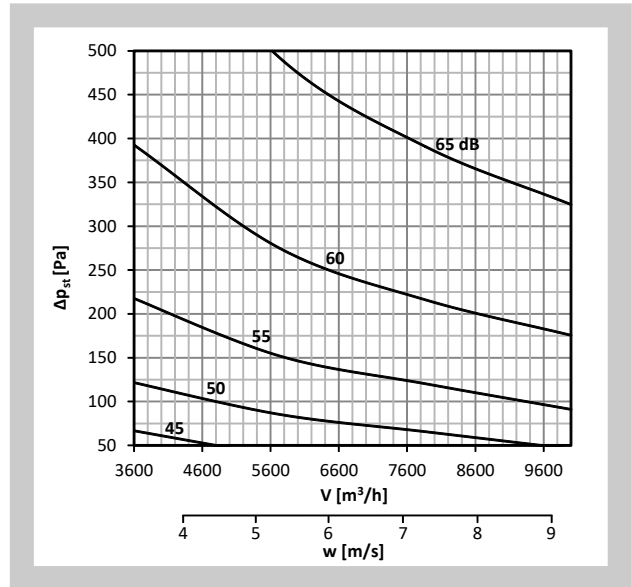
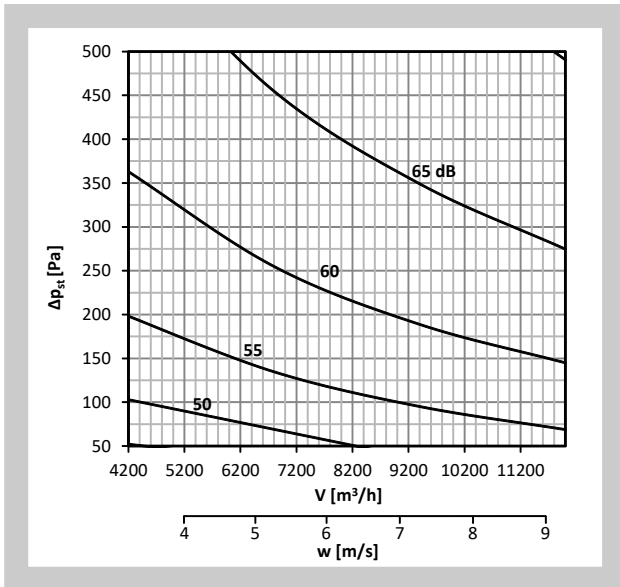

Diagram No. 46 Sound power level L_{WA} [dB(A)] radiated outside the pipeline 600x600, without insulation



8.3. Radiated noise - insulated controller

The radiated noise of air volume controller is listed in Tab. 8.3.1.

\dot{V} [m³·h⁻¹] - air flow volume

Δp_{st} [Pa] - pressure differential

L_{WA} [dB(A)] - total level of acoustic power corrected by filter A

Tab. 8.3.1.

Size	\dot{V} [m ³ /h]	L_{WA} [dB(A)]	L_{WA} [dB(A)]	L_{WA} [dB(A)]	L_{WA} [dB(A)]
		$\Delta p_{st} = 50 \text{ Pa}$	$\Delta p_{st} = 100 \text{ Pa}$	$\Delta p_{st} = 250 \text{ Pa}$	$\Delta p_{st} = 500 \text{ Pa}$
200 x 100	250	24	28	33	38
	400	30	34	39	44
	550	34	38	43	48
	700	37	41	46	52
200 x 150	400	26	29	34	38
	600	32	35	40	44
	800	35	39	44	49
	1000	39	43	48	53
200 x 200	500	28	31	35	39
	765	33	36	41	45
	1035	37	40	46	50
	1300	40	44	50	54
300 x 100	400	27	31	36	41
	600	33	36	41	45
	800	36	39	44	48
	1000	39	42	47	51
300 x 150	500	26	30	36	41
	835	33	37	42	47
	1165	38	41	46	50
	1500	42	45	50	54
300 x 200	600	26	30	38	44
	1065	30	35	43	49
	1535	34	39	47	53
	2000	36	41	49	56
300 x 250	800	26	31	38	45
	1365	31	35	43	50
	1935	35	40	47	54
	2500	38	43	50	57
300 x 300	1000	26	31	39	46
	4665	31	36	44	51
	2335	35	40	48	54
	3000	38	43	51	57
400 x 200	900	24	29	37	44
	1500	29	34	42	48
	2100	32	37	45	51
	2700	35	40	48	54
400 x 250	1200	27	32	40	46
	1935	30	36	44	50
	2665	34	39	47	53
	3400	37	42	50	56

Size	V [m³/h]	L _{WA} [dB(A)]	L _{WA} [dB(A)]	L _{WA} [dB(A)]	L _{WA} [dB(A)]
		Δp _{st} = 50 Pa	Δp _{st} = 100 Pa	Δp _{st} = 250 Pa	Δp _{st} = 500 Pa
400 x 300	1500	29	34	42	48
	2400	34	39	46	52
	3300	37	42	49	55
	4200	40	45	42	57
400 x 400	1800	30	36	43	49
	3000	35	40	47	53
	4200	39	44	51	57
	5400	42	47	54	60
500 x 200	1100	24	28	36	43
	1865	29	33	40	47
	2635	33	37	44	50
	3400	37	41	48	53
500 x 250	1500	26	31	38	44
	2400	30	35	42	48
	3300	33	38	45	51
	4200	37	41	48	54
500 x 300	1800	27	32	39	45
	2800	31	36	43	49
	3800	34	39	46	52
	4800	37	42	49	55
500 x 400	2200	30	34	41	48
	3735	35	39	46	53
	5265	38	43	50	57
	6800	42	47	54	61
500 x 500	3000	35	40	47	53
	4800	38	43	50	56
	6600	41	46	53	59
	8400	44	49	56	62
600 x 200	1800	25	29	37	43
	2865	29	33	41	47
	3935	32	37	45	51
	5000	36	41	48	54
600 x 250	1800	26	31	38	44
	2865	30	35	42	48
	3935	33	38	46	51
	5000	37	42	49	54
600 x 300	2100	27	32	40	46
	3400	31	36	44	50
	4700	34	39	47	53
	6000	36	42	50	56
600 x 400	3000	30	35	42	48
	4665	34	39	46	52
	6335	37	42	49	55
	8000	41	46	52	58
600 x 500	3600	32	37	44	50
	5735	36	41	48	54
	7865	40	45	52	58
	10000	44	49	56	62
600 x 600	4200	35	40	48	54
	6800	39	44	51	57
	9400	42	47	54	60
	12000	46	50	57	62

Diagram No. 47 Sound power level L_{WA} [dB(A)] radiated outside the pipeline 200x100, with insulation

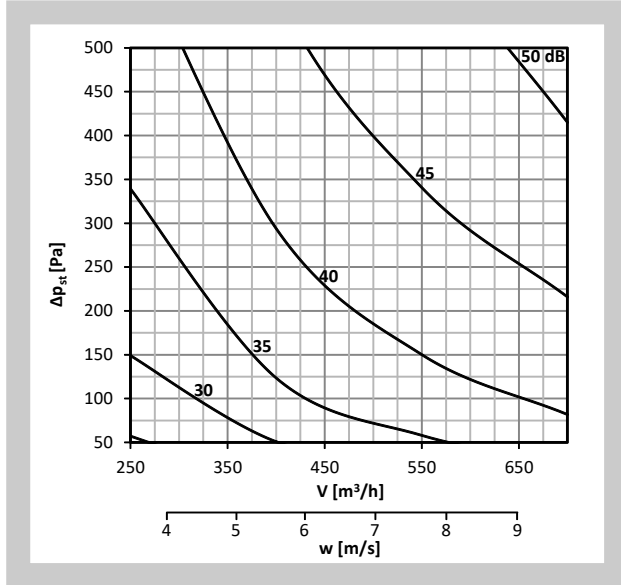

Diagram No. 48 Sound power level L_{WA} [dB(A)] radiated outside the pipeline 200x150, with insulation

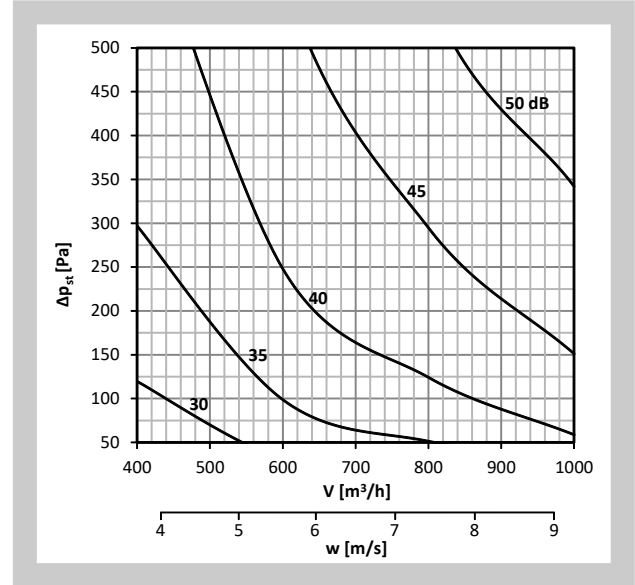

Diagram No. 49 Sound power level L_{WA} [dB(A)] radiated outside the pipeline 200x200, with insulation

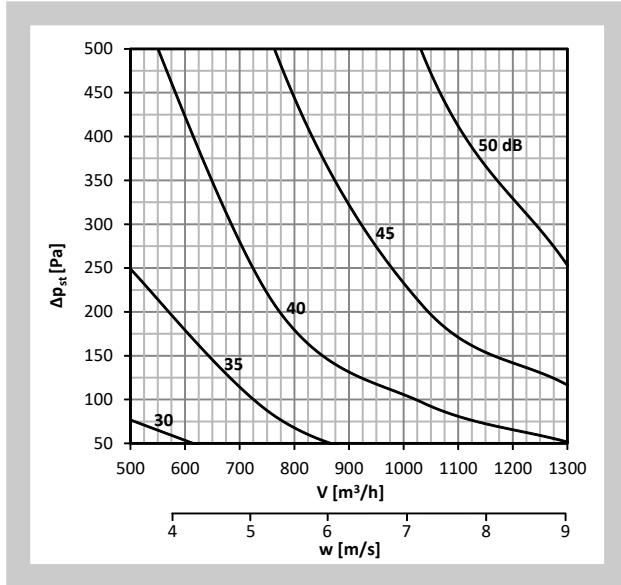

Diagram No. 50 Sound power level L_{WA} [dB(A)] radiated outside the pipeline 300x100, with insulation

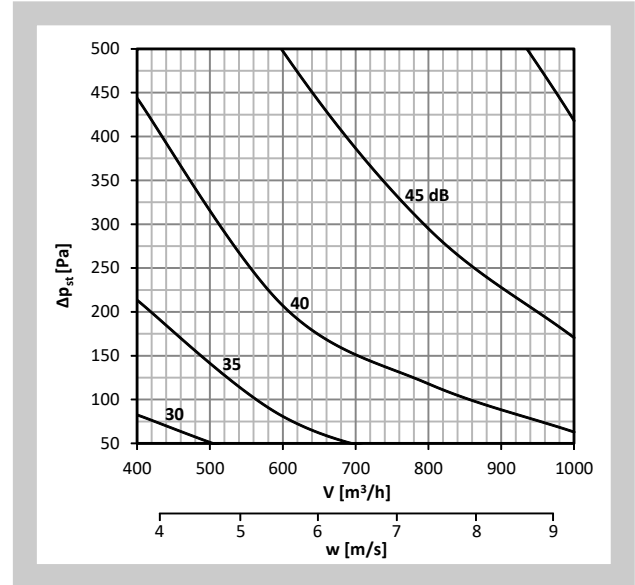

Diagram No. 51 Sound power level L_{WA} [dB(A)] radiated outside the pipeline 300x150, with insulation

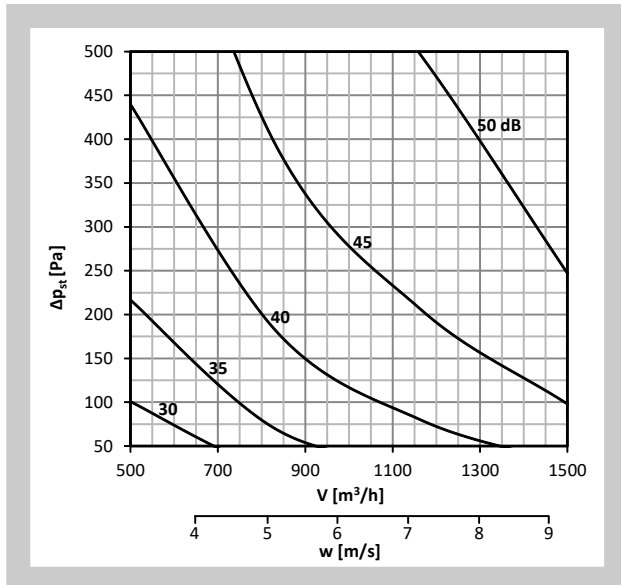

Diagram No. 52 Sound power level L_{WA} [dB(A)] radiated outside the pipeline 300x200, with insulation

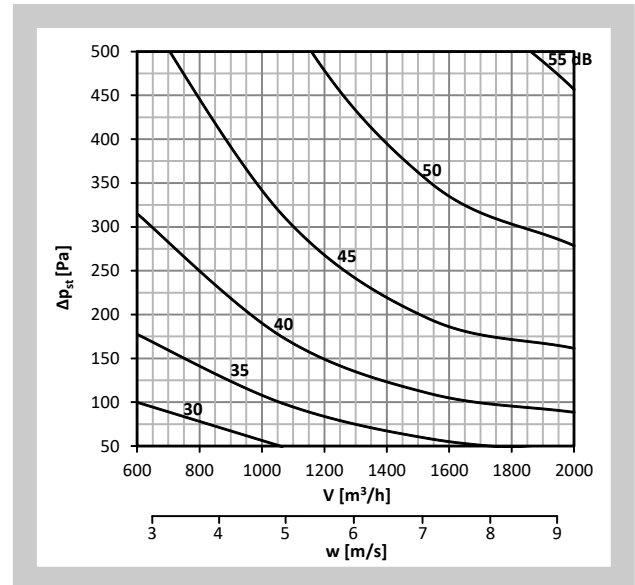

Diagram No. 53 Sound power level L_{WA} [dB(A)] radiated outside the pipeline 300x250, with insulation

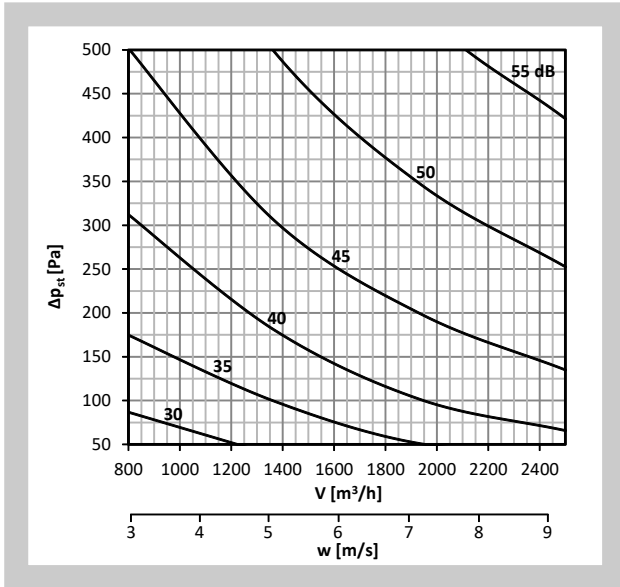

Diagram No. 54 Sound power level L_{WA} [dB(A)] radiated outside the pipeline 300x300, with insulation

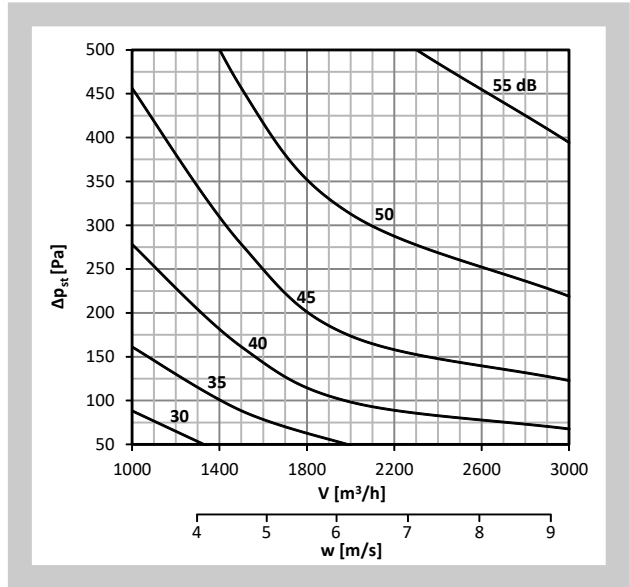

Diagram No. 55 Sound power level L_{WA} [dB(A)] radiated outside the pipeline 400x200, with insulation

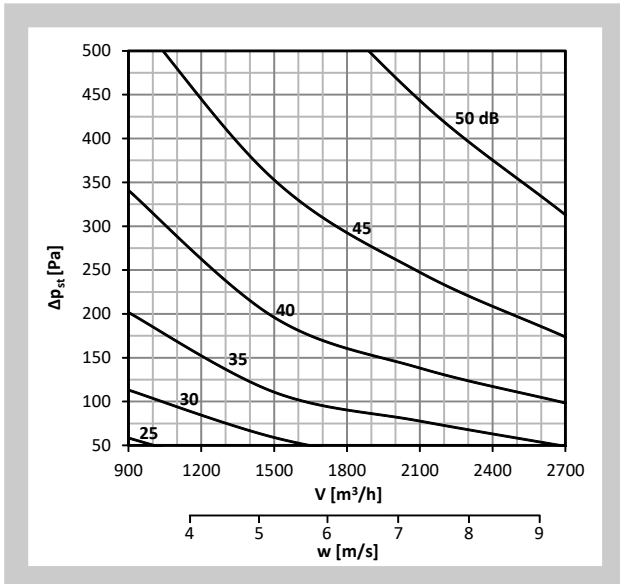

Diagram No. 56 Sound power level L_{WA} [dB(A)] radiated outside the pipeline 400x250, with insulation

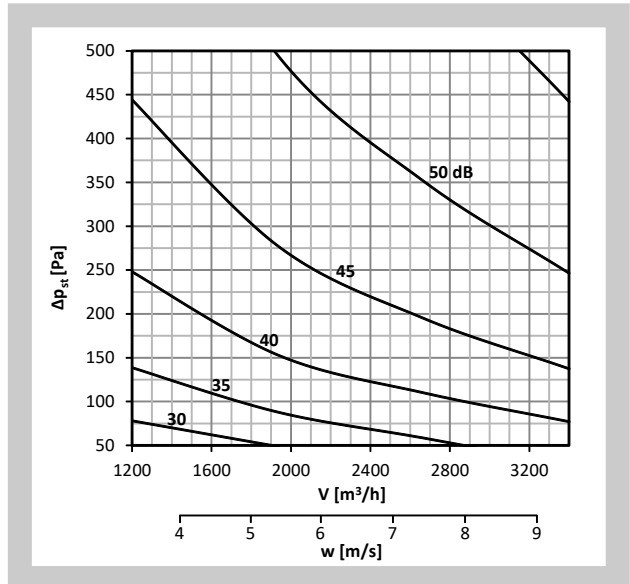

Diagram No. 57 Sound power level L_{WA} [dB(A)] radiated outside the pipeline 400x300, with insulation

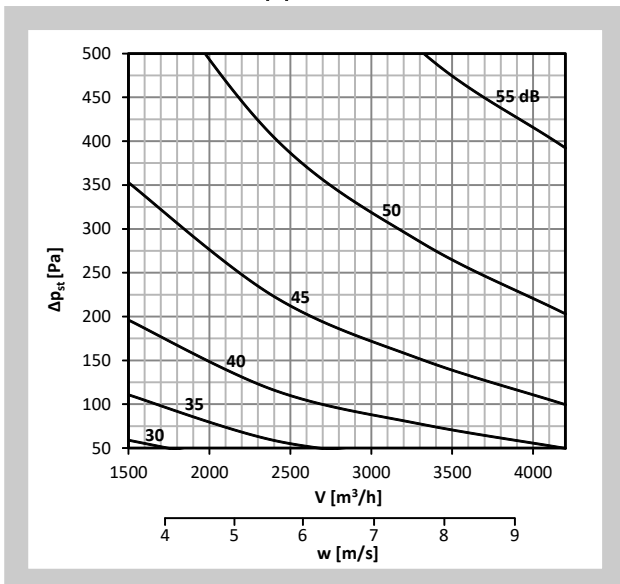

Diagram No. 58 Sound power level L_{WA} [dB(A)] radiated outside the pipeline 400x400, with insulation

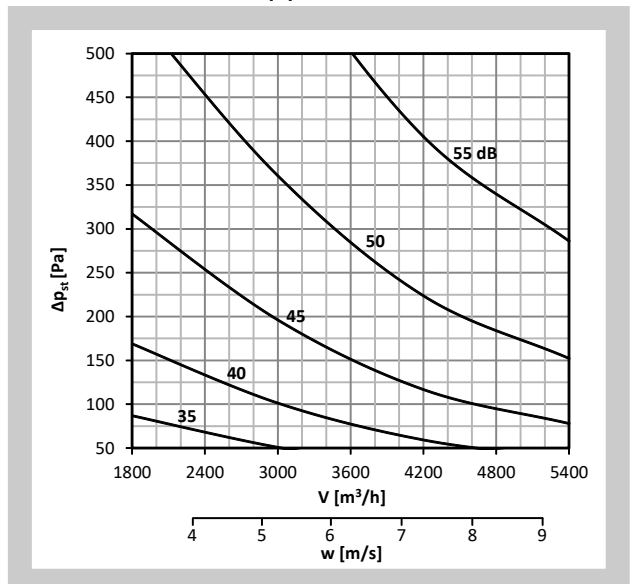

Diagram No. 59 Sound power level L_{WA} [dB(A)] radiated outside the pipeline 500x200, with insulation

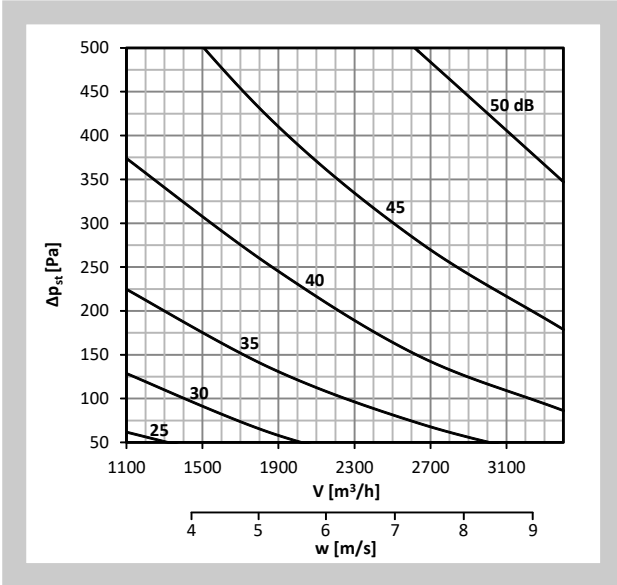

Diagram No. 60 Sound power level L_{WA} [dB(A)] radiated outside the pipeline 500x250, with insulation

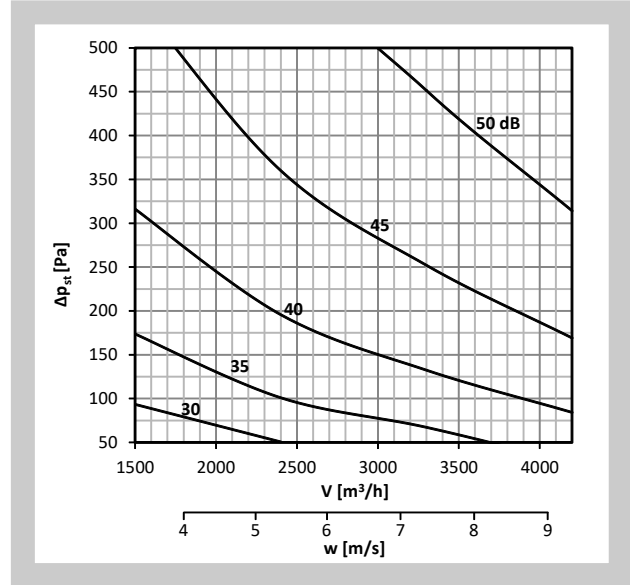

Diagram No. 61 Sound power level L_{WA} [dB(A)] radiated outside the pipeline 500x300, with insulation

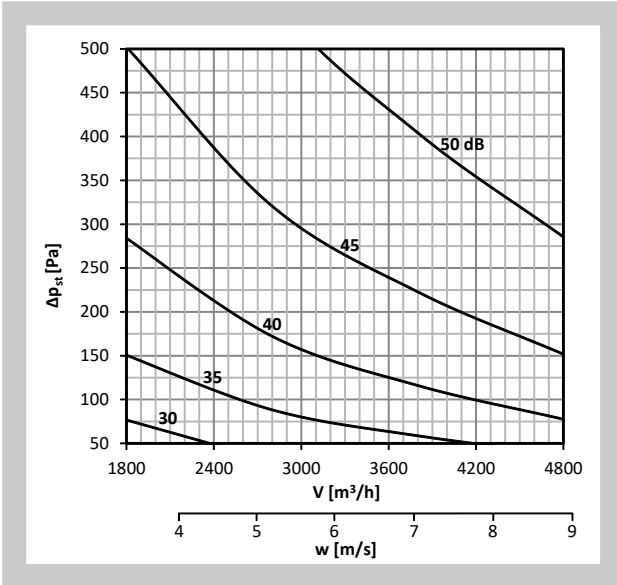

Diagram No. 62 Sound power level L_{WA} [dB(A)] radiated outside the pipeline 500x400, with insulation

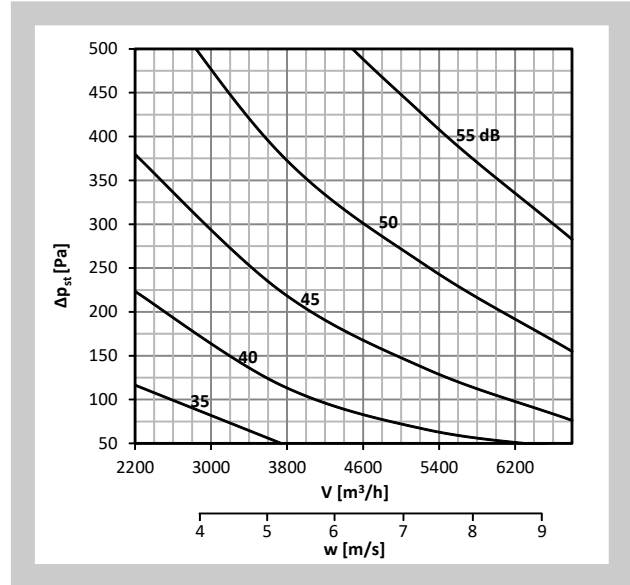

Diagram No. 63 Sound power level L_{WA} [dB(A)] radiated outside the pipeline 500x500, with insulation

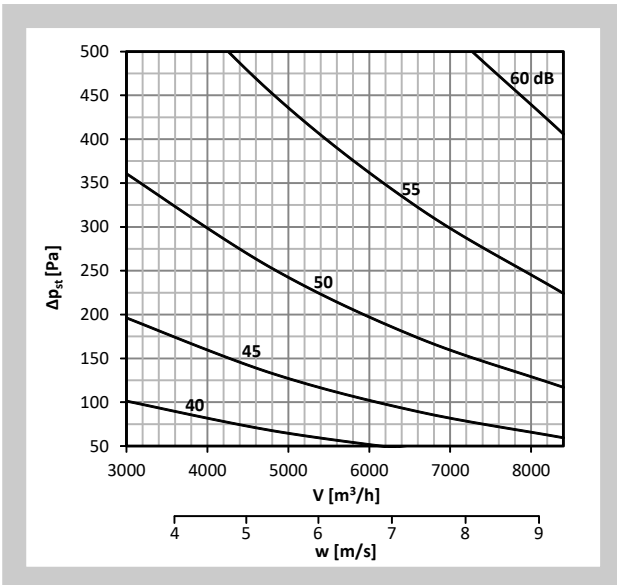

Diagram No. 64 Sound power level L_{WA} [dB(A)] radiated outside the pipeline 600x200, with insulation

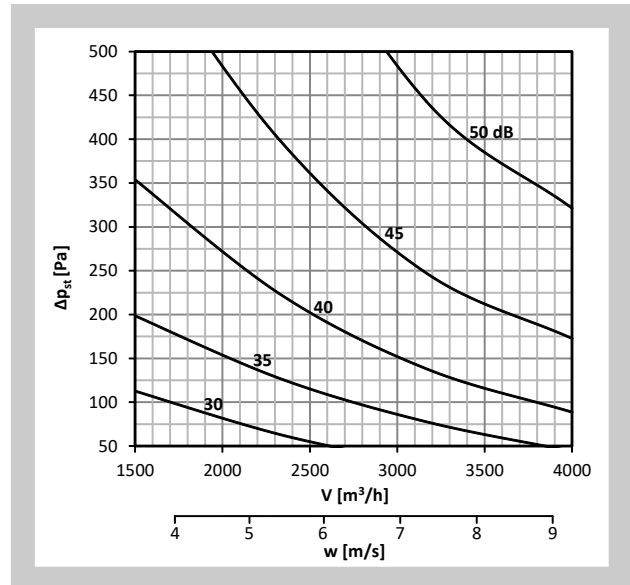

Diagram No. 65 Sound power level L_{WA} [dB(A)] radiated outside the pipeline 600x250, with insulation

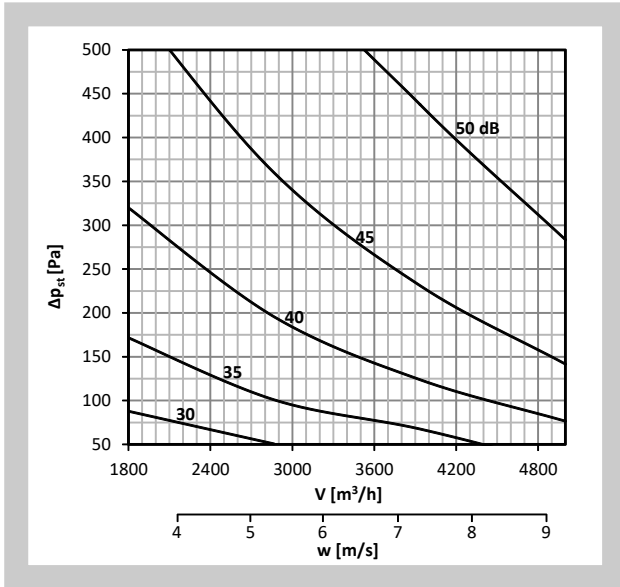

Diagram No. 66 Sound power level L_{WA} [dB(A)] radiated outside the pipeline 600x300, with insulation

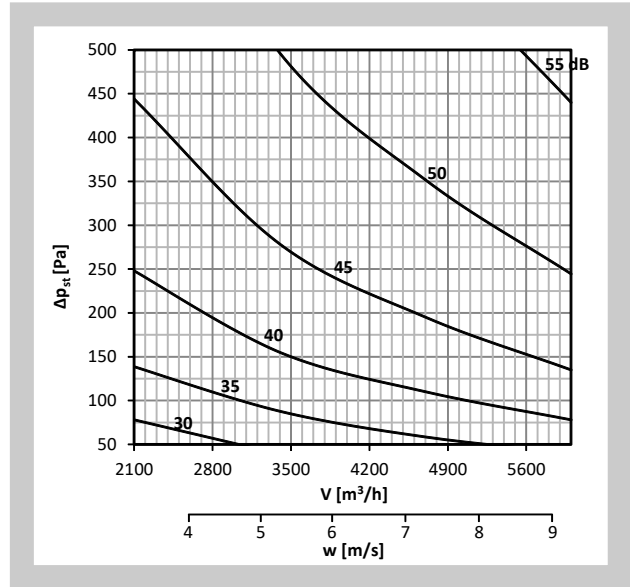

Diagram No. 67 Sound power level L_{WA} [dB(A)] radiated outside the pipeline 600x400, with insulation

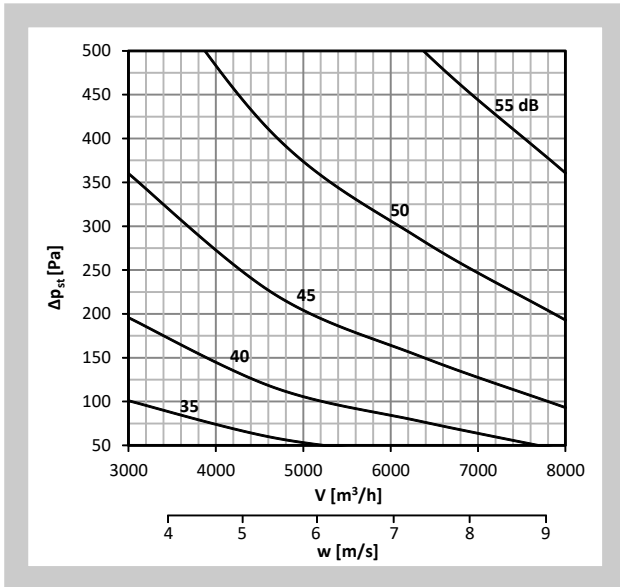

Diagram No. 68 Sound power level L_{WA} [dB(A)] radiated outside the pipeline 600x500, with insulation

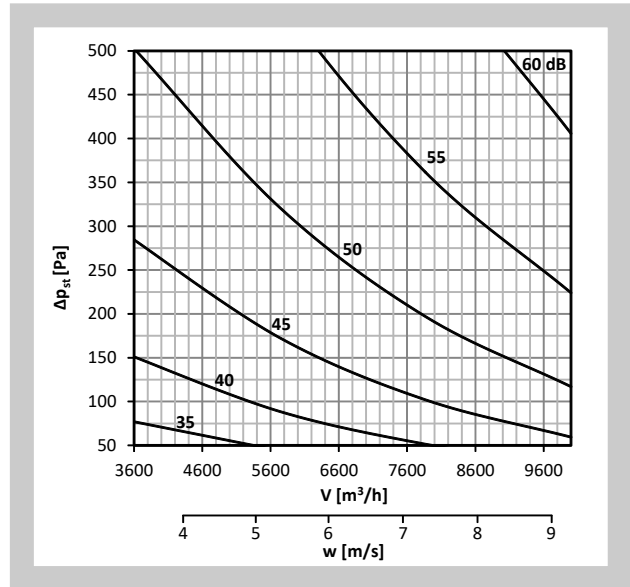
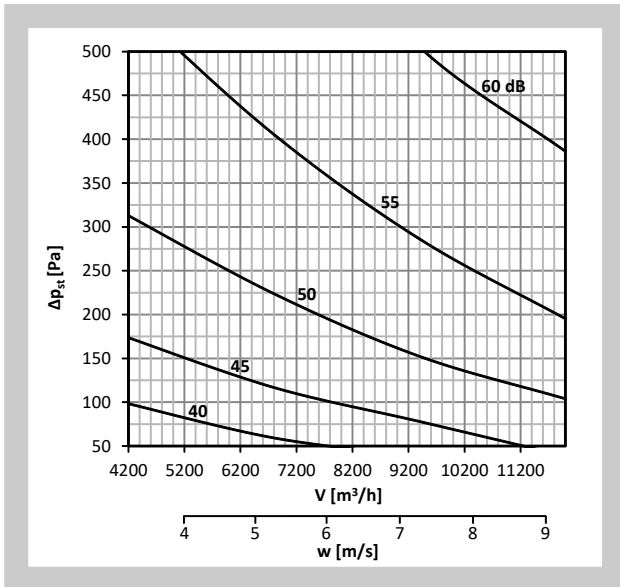

Diagram No. 69 Sound power level L_{WA} [dB(A)] radiated outside the pipeline 600x600, with insulation



IV. MATERIAL, FINISHING

9. Material

9.1. Controller casings and control device parts are made of galvanized steel plate. Controller blade is made of aluminium plate. Damper axis and spring are made of stainless steel. Bearings are made of plastic.

The controller is delivered without further surface treatment.

9.2. According to the customer's requirements, damper can be made of stainless material.

Specifications for stainless-steel models – classification of stainless steel:

- Class A2 – Food-grade stainless steel (AISI 304 – ČSN 17240)

Most metal components of the damper except for the servo drive are made from said stainless steel.

The following components, including the fasteners, are made from AISI304 stainless steel at all times:

- 1) Damper body and all components permanently attached
- 2) Leaf axis + leaf mounting bolts inside the controller
- 3) Control panels (upper, lower)
- 4) Internal mechanical controls – holder of tensioning pin, pin safety, levers, pins
- 5) Control lever including fasteners

Air volume control is manufactured from sheet aluminium.

The air volume control damper has an aluminium shell.

The springs in the control mechanism are stainless steel AISI301 – EN10270-3

Plastic components, sealants, servo drives, and end switches are identical for all material variants of the dampers.

Any other requirements for the design shall be considered atypical and shall be addressed on an individual basis.

V. INSPECTION, TESTING

10. Inspection, testing

10.1. The appliance is constructed and preset by the manufacturer, its operation is dependent on proper installation and adjustment.

VI. TRANSPORTATION AND STORAGE

11. Logistic terms

11.1. Controllers are transported by box freight vehicles without direct weather impact, there must not occur any sharp shocks and ambient temperature must not exceed +40°C. Controllers must be protected against mechanic damages when transported and manipulated.

11.2. Controllers are stored in indoor environment without any aggressive vapours, gases or dust. Indoor temperature must be in the range from -5°C to +40°C and maximum relative humidity 80%. Controllers must be protected against mechanic damages when transported and manipulated.

VII. ORDERING INFORMATION

12. Ordering key

RPMC-K 200x200 I -.57 TPM 105/14

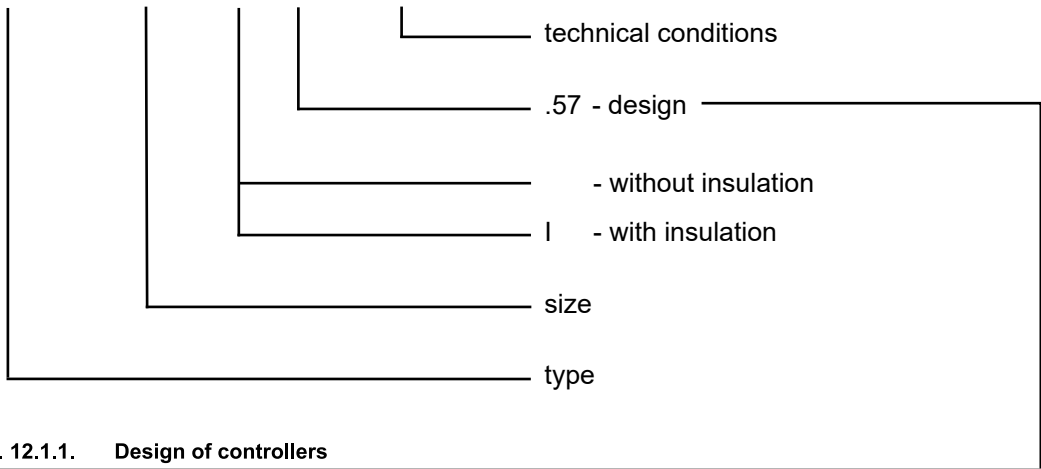

Tab. 12.1.1. Design of controllers

Design - type of control	Additional digits
Manually controlled	.01
Actuating mechanism 230V, open-close control	.45
Actuating mechanism 230V, open-close control, with limit switch	.46
Actuating mechanism 24V, open-close control	.55
Actuating mechanism 24V, open-close control, with limit switch	.56
Actuating mechanism 24V SR modulating control	.57

MANDÍK, a.s.
Dobříšská 550
26724 Hostomice
Czech Republic
Tel.: +420 311 706 706
E-Mail: mandik@mandik.cz
www.mandik.com

The producer reserves the right for innovations of the product. For actual product information see
www.mandik.com